

Invacare® **CS Series Beds**
CS3, CS5, CS7, CS9, CS9FX600



User Manual

EN

For more information regarding bed rail safety, refer to the Bed Rail Entrapment Risk Notification Guide at www.invacare.com.

*This manual MUST be given to the user of the product.
BEFORE using this product, read this manual and save for future reference.*



Yes, you can.®

© 2012 Invacare Corporation. All rights reserved. Republication, duplication or modification in whole or in part is prohibited without prior written permission from Invacare. Trademarks are identified by ™ and ®. All trademarks are owned by or licensed to Invacare Corporation or its subsidiaries unless otherwise noted.
Sherwin-Williams is a registered trademark of Sherwin-Williams.

1	GENERAL	5
	Symbols	5
	Limited Warranty	7
2	SAFETY	8
	General Guidelines	8
	Operation Information	9
	EMI Information.....	14
3	EMC INFORMATION	16
	Electromagnetic Compatibility (EMC) Information	16
4	PRODUCT LABELING	21
5	TECHNICAL DATA	23
	Typical Product Parameters	23
	Mattress Specifications.....	28
6	SET-UP	29
	Unpacking Instructions	29
	Assembly Instructions.....	32
7	USAGE	37
	Hand Control - Pendant Operation	37
	Pendant Storage and Location	39
	Power Cord Storage.....	41
	Raise and Lower the Heel Lift Ratchet.....	42
	Foot Pad Lock Mechanism on CS3 Bed.....	43
	Bed Steer Mechanism.....	44

CONTENTS

8	OPTIONS	45
	Safety Information For Options.....	45
	Bed Rails and Positioning Devices.....	48
	Other Accessories.....	48
	Optional Drainage Bag Holder	49
	Optional Touch-up Paint.....	49
	Optional Attendant Control Panel Operation.....	50
	Optional Trendelenburg and Reverse Trendelenburg Attendant Control Panel.....	53
	Pendant HI/LO Lock Out - Optional	54
	Optional Cardiopulmonary Resuscitation (CPR) Release.....	55
	Optional 39 Inch and 42 Inch Wide Decks	57
	Adjustable Width Bed Model CS9FX600.....	58
9	MAINTENANCE	63
	Cleaning Instructions.....	63
	Annual Maintenance Check	64
	Quarterly Maintenance Check.....	64
	Environmental Conditions for Storage and Transport	64
	Environmental Conditions for Operation.....	64
10	TROUBLESHOOTING	65

I General

I.1 Symbols

Warnings

Signal words are used in this manual and apply to hazards or unsafe practices which could result in personal injury or property damage. See the information below for definitions of the signal words.



DANGER

Danger indicates an imminently hazardous situation which, if not avoided, will result in death or serious injury.



WARNING

Warning indicates a potentially hazardous situation which, if not avoided, could result in death or serious injury.



CAUTION

Caution indicates a potentially hazardous situation which, if not avoided, may result in property damage or minor injury or both.



IMPORTANT

Indicates a hazardous situation that could result in damage to property if it is not avoided.



Gives useful tips, recommendations and information for efficient, trouble-free use.

I GENERAL

Symbols used on the CS Bed

 PROTECTIVE CONDUCTOR TERMINAL

 EQUIPOTENTIALITY

 WARNING - SAFE WORKING LOAD

 THE MAXIMUM ALLOWABLE LOAD ON EQUIPMENT IF THE INSTRUCTIONS FOR INSTALLATION AND USE ARE FOLLOWED

 ALTERNATING CURRENT

 ON - SUPPLY

 OFF - SUPPLY

IPX4 INTERNATIONAL PROTECTION CODE (04 - PROTECTION AGAINST WATER SPRAY FROM ANY DIRECTION)

 APPLIED PART TYPE B EQUIPMENT

CLASS I EQUIPMENT CLASSIFICATION IN TERMS OF PROTECTION AGAINST ELECTRICAL SHOCK

 Intertek's ETL Listed Mark for US and Canada. A product bearing the ETL Listed Mark is determined to have met the minimum requirements of prescribed product safety standards.

 Battery Charging (Yellow)

(on Trend ACP)

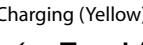
 Battery Fully Charged (Green)

 Lift with Two Persons (based on ISO 3864)

 FUNCTION LOCK-OUT
ACTIVATE TOGGLE SWITCH TO DENY FUNCTION ACCESS ON THE HAND PENDANT

 INITIATE ACTION TO THE ENTIRE MATTRESS SUPPORT PLATFORM (HILD)

 INITIATE ACTION TO HEAD SECTION OF MATTRESS SUPPORT PLATFORM

 TOGGLE SWITCH FOR ONE-TOUCH HEAD AND KNEE-FOOT RAISE OPERATION

 INITIATE ACTION TO THE KNEE-FOOT SECTION OF THE MATTRESS SUPPORT PLATFORM

 UP CONTROL - RAISE THE CORRESPONDING SECTION OF THE MATTRESS SUPPORT PLATFORM

 DOWN CONTROL - LOWER THE CORRESPONDING SECTION OF THE MATTRESS SUPPORT PLATFORM

 Trendelenburg Function

 Reverse Trendelenburg Function

 General warning symbol (ISO 3864)

 Danger: electricity, electrical hazard symbol (IEC 61310, ISO 3864)

 Explosive material, explosion hazard symbol (IEC 61310)

 Flammable material symbol (IEC 61310)

 Crush hazard symbol (based on ANSI Z535)

 Crush hazard symbol (based on ANSI Z535)

 Crush hazard symbol (based on ANSI Z535)

 Drop / Fall Hazard symbol (based on IEC 61310)

1.2 Limited Warranty



PLEASE NOTE: THE WARRANTY BELOW HAS BEEN DRAFTED TO COMPLY WITH FEDERAL LAW APPLICABLE TO PRODUCTS MANUFACTURED AFTER JULY 4, 1975.

This warranty is extended only to the original purchaser who purchases this product when new and unused from Invacare Continuing Care, Inc (ICCI) or a dealer. This warranty is not extended to any other person or entity and is not transferable or assignable to any subsequent purchaser or owner. Coverage under this warranty will end upon any such subsequent sale or other transfer of title to any other person.

This warranty gives you specific legal rights and you may also have other legal rights which vary from state to state.

ICCI warrants the frame and welds on this product when purchased new and unused will be free from structural defects on the frame for a period of ten (10) years, electrical for a period of three (3) years, and mechanical for a period of five (5) years from date of purchase from ICCI or a dealer, with a copy of the seller's invoice required for coverage under this warranty. ICCI warrants the frame of this product when purchased new and unused to be free from defects in materials and workmanship for a period of ten (10) years from date of purchase from ICCI or a dealer, with a copy of the seller's invoice required for coverage under this warranty. For all other components of this product when purchased new and unused, ICCI warrants that they will be free from defects in material and workmanship for a period of one (1) year from date of purchase from ICCI or a dealer, with a copy of the seller's invoice required for coverage under this warranty. Upholstery (vinyls, fabrics and/or laminates) are not covered under this warranty. If within such warranty periods any such product shall be proven to be defective, such product shall be repaired or replaced, at ICCI's option. This warranty does not include any labor or shipping charges incurred in replacement part installation or repair of any such product. ICCI's sole obligation and your exclusive remedy under this warranty shall be limited to such repair and/or replacement. For warranty service, please contact the dealer from whom you purchased your ICCI product. In the event you do not receive satisfactory warranty service, please write directly to ICCI at the address on the back cover, provide dealer's name, address, and the date of purchase, indicate nature of the defect and, if the product is serialized, indicate the serial number. Do not return products to our factory without our prior consent.

LIMITATIONS AND EXCLUSIONS: THE FOREGOING WARRANTY SHALL NOT APPLY TO SERIAL NUMBERED PRODUCTS IF THE SERIAL NUMBER HAS BEEN REMOVED OR DEFACED, PRODUCTS SUBJECTED TO NEGLIGENCE, ACCIDENT, IMPROPER OPERATION, MAINTENANCE OR STORAGE, PRODUCTS MODIFIED WITHOUT ICCI'S EXPRESS WRITTEN CONSENT (INCLUDING, BUT NOT LIMITED TO, MODIFICATION THROUGH THE USE OF UNAUTHORIZED PARTS OR ATTACHMENTS; PRODUCTS DAMAGED BY REASON OF REPAIRS MADE TO ANY COMPONENT WITHOUT THE SPECIFIC CONSENT OF ICCI, OR TO A PRODUCT DAMAGED BY CIRCUMSTANCES BEYOND ICCI'S CONTROL, AND SUCH EVALUATION WILL BE SOLELY DETERMINED BY ICCI. THE WARRANTY SHALL NOT APPLY TO NORMAL WEAR AND TEAR OR FAILURE TO ADHERE TO THE PRODUCT INSTRUCTIONS.

"THE FOREGOING EXPRESS WARRANTY IS EXCLUSIVE AND IN LIEU OF ANY OTHER WARRANTIES WHATSOEVER, WHETHER EXPRESS OR IMPLIED, INCLUDING THE IMPLIED WARRANTIES OF MERCHANTABILITY AND FITNESS FOR A PARTICULAR PURPOSE, AND THE SOLE REMEDY FOR VIOLATIONS OF ANY WARRANTY WHATSOEVER, SHALL BE LIMITED TO REPAIR OR REPLACEMENT OF THE DEFECTIVE PRODUCT PURSUANT TO THE TERMS CONTAINED HEREIN. THE APPLICATION OF ANY IMPLIED WARRANTY WHATSOEVER SHALL NOT EXTEND BEYOND THE DURATION OF THE EXPRESS WARRANTY PROVIDED HEREIN. ICCI SHALL NOT BE LIABLE FOR ANY CONSEQUENTIAL OR INCIDENTAL DAMAGES WHATSOEVER."

2 Safety

The Safety section contains important information for the safe operation and use of this product.

2.1 General Guidelines



DANGER: RISK OF INJURY OR DEATH

Use **ONLY Invacare** rails, mattresses, bed extenders and other accessories with Invacare bed products.

Bed accessories designed by other manufacturers have **NOT** been tested by Invacare. Use of **NON-Invacare** bed accessories may result in injury or death.



WARNING

DO NOT use this product or any available optional equipment without first completely reading and understanding these instructions and any additional instructional material such as owner's manuals, service manuals or instruction sheets supplied with this product or optional equipment. If you are unable to understand the warnings, cautions or instructions, contact a healthcare professional, dealer or technical personnel before attempting to use this equipment - otherwise, injury or damage may occur.

The initial set up of this bed must be performed by a qualified technician. Procedures other than those described in this manual must be performed by a qualified technician.



NOTICE

THE INFORMATION CONTAINED IN THIS DOCUMENT IS SUBJECT TO CHANGE WITHOUT NOTICE.

Check all parts for shipping damage and test before using. In case of damage, DO NOT use. Contact ICCI Customer Service Department (1-800-668-2337)/Carrier for further instruction.

This Manual/Electric bed has been engineered to provide reliable operation. The bed has been thoroughly tested and inspected prior to shipment.

2.2 Operation Information

General Warnings



WARNING

When bed is not to be used for an extended period, unplug electric bed from the wall outlet.

The electric bed is NOT designed to be used as a patient transport. When transporting a patient, use an approved patient transport. Otherwise, injury or damage may result.

If the unit is not working properly, call a qualified technician to examine the unit and repair it.

Keep all moving parts, including the main frame, mattress deck (head and foot sections) and all drive shafts, free of obstruction (i.e. chair rails, consoles, window sills, blankets/sheets, heating blankets/pads, tubing, wiring, etc. and other types of products using electric cords which may get tangled around the bed, side rails or legs) during operation of the electric bed. Never store anything under the bed.

The electric bed is equipped with locking casters. When transferring into or out of the electric bed, always lock the locking caster(s). Inspect the wheel locks for correct locking action before actual use. Even with casters properly locked some flooring surfaces such as tile or wood will allow the bed to move under some conditions. Use on surfaces such as these must be evaluated by the care provider.

After any adjustments, repair or service and before use, make sure all attaching hardware is tightened securely.

If a liquid is spilled in or around the electric bed, unplug the electric bed before cleaning. Clean up the spill and allow the electric bed or the area around the electric bed to dry thoroughly before using the electric controls again.

When operating/moving electric beds, always ensure that the individual utilizing the bed is positioned properly within the confines of the bed. DO NOT let any extremities protrude over the side or between the bed rails when performing these functions.

Hang pendant on hook or secure with linen clip when not in use. Keep cord clear of moving parts. DO NOT roll the bed over the power cord or pendant cord. DO NOT entangle the cords on other objects. A pinched electric cord is dangerous and can become damaged. Use the Power Cord Strap when moving the bed. Refer to Pendant Storage and Location on page 39 and Power Cord Storage on page 41.

2 SAFETY

Weight Limitation



WARNING

This bed is rated to 600 lbs. (272 kg) for model CS9FX600, 500 lbs. (228 kg) for models CS5, CS7, and CS9 and 450 lbs. (204 kg) for model CS3. **DO NOT** overload the bed. The combined weight of patients, visitors, mattress, bedding and all accessories must **NOT** exceed rated capacity or Safe Working Load.

Body weight should be evenly distributed over the surface of the bed. **DO NOT** lay, sit or lean in such a way that your entire body weight is placed only on raised head or foot sections of the bed. This includes when assisting the user in repositioning or transferring in or out of bed.

DO NOT drop the bed. **DO NOT** allow patients to fall on the bed. **DO NOT** jump on the bed.

Each of the preceding impacts can permanently damage either HI/LO motor resulting in an inoperable bed. In the case of an inoperable bed due to a damaged HI/LO motor, the HI/LO motor must be replaced immediately. If left unattended, a damaged HI/LO motor can cause the bed to fall from the highest extended position, resulting in patient injury. **DO NOT** exceed the maximum continuous duty cycle. Refer to Technical Specifications.

NEVER allow patients to use trapeze or traction units as a total individual weight support. Trapeze units are to be used only for immobilizing a patient in various traction set-ups or assisting the patient in repositioning or transferring into or out of bed.

Entrapment Warnings



WARNING

Refer to the **Bed Rail Entrapment Risk Notification Guide** at www.invacare.com.

If patient assessment concludes that the patient's condition increases the chance of entrapment, the bed **MUST** be in the flat position when left unattended.

Repair or Service Information



DANGER

After any adjustments, repair or service and before use, make sure all attaching hardware is tightened securely. **DO NOT** open assemblies such as the motors, pendant, control boxes or gearboxes. No user serviceable parts are inside. Only qualified technicians are permitted to repair these parts. If unqualified individuals perform any work on these beds, the warranty is void.

Unplug the power cord from its power source before performing any maintenance on the electric bed. **DO NOT** unplug the power cord from the control box. Damage to cord will result.

The control box is mounted to the head motor with a cable tie. If replacing the control box, remove the cable tie and slide the control box away from the head motor until it is free. Disconnect all cable connections.

Before connecting/disconnecting the connections at the control box, make sure the cable lock is removed by lightly depressing on the end tabs and lifting. After connectors are plugged in, route all cables into the cable lock slots and snap the cable lock in place. When installing any connectors into the control box, be sure the cable lock is secure after installation - otherwise, injury or damage may occur.

DO NOT force the connector into the control box, otherwise - injury or damage may occur.

Fire Hazard



DANGER

Possible fire hazard when used with oxygen administering equipment other than nasal or masked type.

Use masked or nasal type oxygen administering equipment only in conjunction with the manual/electric bed. The use of any other type of oxygen administering equipment can result in a fire hazard.

When using nasal or masked type oxygen administering equipment, the oxygen or air tubing **MUST** be routed and secured properly to ensure that the tubing does not become entangled and/or severed during normal operation of manual/electric bed.

2 SAFETY

Explosion Hazard



DANGER

EXPLOSION Hazard. DO NOT operate this bed in the presence of a flammable anaesthetic mixture with air or with nitrous oxide. DO NOT use near explosive gases.

Keep the product a minimum of 12" away from any direct heat source.

Electrical and Grounding



DANGER

NEVER operate if the unit has a damaged cord or plug. If it is not working properly, call a qualified technician for examination and repair. Keep all electrical cords away from heated or hot surfaces. Ensure all cables and cords are routed such that they will not become entangled or pinched. Otherwise damage or injury may result.

If grounding is not reliable, unplug the bed and use the battery power, if equipped.

DO NOT unplug power cord from control box.

The pendant and power cords must be routed and secured properly to ensure that the cords DO NOT become entangled, pinched and/or severed during operation of the electric bed.

NEVER operate the unit if these cords are damaged.

Refer servicing to qualified personnel only. Grounding reliability depends upon a properly grounded wall outlet.

Improper connection of the equipment-grounding conductor can result in electrocution. Check with a qualified electrician or service person if you are doubtful that the electrical outlet is properly grounded. DO NOT modify the grounding plug provided. If it will not fit into the electrical outlet, have a proper outlet installed by a qualified electrician. Grounding reliability can only be achieved when connected to an equivalent receptacle marked Hospital Only or Hospital Grade.

In the event of a power outage, the bed can be powered by its internal battery but MUST remain plugged into the grounded outlet for proper grounding.

Electric components, such as motors may cause severe injury including electrocution if exposed to water.

During routine bed operation or when cleaning, DO NOT expose electrical components to water. Unplug and de-energize electrical components when water products are near these components.

**WARNING**

To de-energize the bed it must be unplugged from the wall outlet and the battery must be disconnected from the controller to prohibit operation.

DO NOT use an extension cord.

DO NOT permit the cord, wall outlet, motors, control box or pendant to become wet or submerged.

DO NOT operate the bed if the cord or outlet is damaged. DO NOT operate the bed if any motor has malfunctioned or is damaged in any manner.

DO NOT use this bed in Active Treatment “Ether Environments”.

Plug the three prong electrical cord ONLY into a properly grounded 110 VAC to 120 VAC, 60 cycle outlet that is rated to at least six amps. This electric bed must be grounded. In the event of a malfunction or breakdown, grounding provides a path of least resistance for electric current, thereby reducing the risk of electric shock.

This product is equipped with a cord having an equipment-grounding conductor and a grounded plug. The plug must be inserted into an appropriate electric outlet that is properly installed and grounded in accordance with all local codes and ordinances.

**CAUTION**

A safety feature of this product includes protection against overheating caused by excessive or extended periods of operation. Depending on the duration, this includes multiple or repeated adjustments or the use of multiple functions at one time. To assure trouble free operation, ALWAYS allow a slight pause between multiple adjustments and avoid pressing more than one function button at a time. If thermal protection activation should occur, the bed will not respond to pendant commands. Given this situation, release the pendant button and allow the bed unit to sit for several minutes. This will allow the protection function time to reset and restore bed function. Depending on the severity of the initial overheating, this could take up to 30 minutes.

2 SAFETY

Battery



WARNING

Charge battery through the controller. NEVER attempt to charge the battery by any other means. Internal battery should be tested monthly.

2.3 EMI Information



CAUTION

IT IS VERY IMPORTANT THAT YOU READ THIS INFORMATION REGARDING THE POSSIBLE EFFECTS OF ELECTROMAGNETIC INTERFERENCE ON THIS PRODUCT.

Electromagnetic Interference (EMI) From Radio Wave Sources

This product may be susceptible to electromagnetic interference (EMI), which is interfering electromagnetic energy (EM) emitted from sources such as radio stations, TV stations, amateur radio (HAM) transmitters, two way radios, and cellular phones. The interference (from radio wave sources) can cause the powered bed to release its brakes, move by itself, or move in unintended directions. It can also permanently damage the powered bed's control system. The intensity of the interfering EM energy can be measured in volts per meter (V/m). Each powered bed can resist EMI up to a certain intensity. This is called its "immunity level." The higher the immunity level, the greater the protection. At this time, current technology is capable of achieving at least a 20 V/m immunity level, which would provide useful protection from the more common sources of radiated EMI.

There are a number of sources of relatively intense electromagnetic fields in the everyday environment. Some of these sources are obvious and easy to avoid. Others are not apparent and exposure is unavoidable. However, we believe that by following the warnings listed below, your risk to EMI will be minimized.

The sources of radiated EMI can be broadly classified into three types:

1. Hand-held Portable transceivers (transmitters-receivers with the antenna mounted directly on the transmitting unit. Examples include: citizens band (CB) radios, "walkie talkie", security, fire and police transceivers, cellular telephones, and other personal communication devices).



Some cellular telephones and similar devices transmit signals while they are ON, even when not being used.

2. Medium-range mobile transceivers, such as those used in police cars, fire trucks, ambulances and taxis. These usually have the antenna mounted on the outside of the vehicle; and

3. Long-range transmitters and transceivers, such as commercial broadcast transmitters (radio and TV broadcast antenna towers) and amateur (HAM) radios.
-  Other types of hand-held devices, such as cordless phones, laptop computers, AM/FM radios, TV sets, CD players, cassette players, and small appliances, such as electric shavers and hair dryers, so far as we know, are not likely to cause EMI problems to this product.

Pinch Point



WARNING

Pinch point between rail and floor is created when lowering the bed to the lowest position.

Keep feet clear of bed when lowering bed.

Close supervision is necessary when this product is used near or by children or people with disabilities. **DO NOT** let any individual underneath the bed or in between the raised bed frame components at any time.

Disposal



WARNING

This product has been supplied from an environmentally aware manufacturer that complies with the Waste Electrical and Electronic Equipment (WEEE) Directive 2002/96/CE.

This product may contain substances that could be harmful to the environment if disposed of in places (landfills) that are not appropriate according to legislation.

Please be environmentally responsible and recycle this product through your recycling facility at its end of life.

3 EMC Information

3.1 Electromagnetic Compatibility (EMC) Information



Medical Electrical Equipment needs special precautions regarding EMC and needs to be installed and put into service according to the EMC information provided in this manual.

Portable and mobile RF communications equipment can affect medical electrical equipment.



WARNINGS

The use of accessories, transducers, and cables other than those specified by the manufacturer, may result in increased emissions or decreased immunity of this bed.

This bed should not be used adjacent to or stacked with other equipment and that if adjacent or stacked use is necessary, this bed should be observed to verify normal operation in the configuration in which it will be used.

Guidance and Manufacturer's Declaration - Electromagnetic Emissions

The CS Bed is intended for use in the electromagnetic environment specified below. The customer or the user of the CS Bed should assure that it is used in such an environment.

Emissions Test	Compliance	Electromagnetic Environment - Guidance
RF emissions CISPR 11	Group 1	The CS Bed uses RF energy only for its internal function. Therefore, its RF emissions are very low and are not likely to cause any interference in nearby electronic equipment.
RF emissions CISPR 11	Class B	The CS Bed is suitable for use in all establishments, including domestic establishments and those directly connected to the public low-voltage power supply network that supplies buildings used for domestic purposes.
Harmonic emissions IEC 61000-3-2	Class A	
Voltage fluctuations / flicker emissions IEC 61000-3-3	Complies	

Guidance and Manufacturer's Declaration - Electromagnetic Immunity

The CS Bed is intended for use in the electromagnetic environment specified below. The customer or the user of the CS Bed should assure that it is used in such an environment.

Immunity Test	IEC 60601 Test Level	Compliance Level	Electromagnetic Environment - Guidance
Electrostatic discharge (ESD) IEC 61000-4-2	±6 kV contact ±8 kV air	±6 kV contact ±8 kV air	Floors should be wood, concrete or ceramic tile. If floors are covered with synthetic material, the relative humidity should be at least 30 %.
Electrical fast transient/burst IEC 61000-4-4	±2 kV for power supply lines ±1 kV for input/output lines	±2 kV for power supply lines ±1 kV for input/output lines	Mains power quality should be that of a typical commercial or hospital environment.
Surge IEC 61000-4-5	±1 kV differential mode ±2 kV common mode	±1 kV differential mode ±2 kV common mode	Mains power quality should be that of a typical commercial or hospital environment.
Voltage dips, short interruptions and voltage variations on power supply input lines IEC 61000-4-11	<5 % U_T (>95 % dip in U_T) for 0,5 cycle 40 % U_T (60 % dip in U_T) for 5 cycles 70 % U_T (30 % dip in U_T) for 25 cycles <5 % U_T (>95 % dip in U_T) for 5 sec	<5 % U_T (>95 % dip in U_T) for 0,5 cycle 40 % U_T (60 % dip in U_T) for 5 cycles 70 % U_T (30 % dip in U_T) for 25 cycles <5 % U_T (>95 % dip in U_T) for 5 sec	Mains power quality should be that of a typical commercial or hospital environment. If the user of the CS Bed requires continued operation during power mains interruptions, it is recommended that the CS Bed be powered from an uninterruptible power supply or a battery.

3 EMC INFORMATION

Guidance and Manufacturer's Declaration - Electromagnetic Immunity			
Power frequency (50/60 Hz) magnetic field IEC 61000-4-8	3 A / m	3 A / m	Power frequency magnetic fields should be at levels characteristic of a typical location in a typical commercial or hospital environment.
NOTE U _T is the a.c. mains voltage prior to application of the test level.			

Guidance and Manufacturer's Declaration - Electromagnetic Immunity			
The CS Bed is intended for use in the electromagnetic environment specified below. The customer or the user of the CS Bed should assure that it is used in such an environment.			
Immunity Test	IEC 60601 Test Level	Compliance Level	Electromagnetic Environment - Guidance
Conducted RF IEC 61000-4-6	3 Vrms 150 kHz to 80 MHz	3 Vrms	<p>Portable and mobile RF communications equipment should be used no closer to any part of the CS Bed, including cables, than the recommended separation distance calculated from the equation applicable to the frequency of the transmitter.</p> <p>Recommended separation distance</p> $d = 1.2 \sqrt{P}$

Guidance and Manufacturer's Declaration - Electromagnetic Immunity

Radiated RF IEC 61000-4-3	3 V/m 80 MHz to 2,5 GHz	3 V/m	$d=1.2 \sqrt{P}$ 80 MHz to 800 MHz $d=2.3 \sqrt{P}$ 800 MHz to 2,5 GHz where P is the maximum output power rating of the transmitter in watts (W) according to the transmitter manufacturer and d is the recommended separation distance in metres (m). Field strengths from fixed RF transmitters, as determined by an electromagnetic site survey, ^a should be less than the compliance level in each frequency range. ^b Interference may occur in the vicinity of equipment marked with the following symbol: 
------------------------------	-------------------------------	-------	---

NOTE 1 At 80 MHz and 800 MHz, the higher frequency range applies.

NOTE 2 These guidelines may not apply in all situations. Electromagnetic propagation is affected by absorption and reflection from structures, objects and people.

- a Field strengths from fixed transmitters, such as base stations for radio (cellular/cordless) telephones and land mobile radios, amateur radio, AM and FM radio broadcast and TV broadcast cannot be predicted theoretically with accuracy. To assess the electromagnetic environment due to fixed RF transmitters, an electromagnetic site survey should be considered. If the measured field strength in the location in which the CS Bed is used exceeds the applicable RF compliance level above, the CS Bed should be observed to verify normal operation. If abnormal performance is observed, additional measures may be necessary, such as re-orienting or relocating the CS Bed.
- b Over the frequency range 150 kHz to 80 MHz, field strengths should be less than 3 V/m.

3 EMC INFORMATION

Recommended separation distances between portable and mobile RF communications equipment and the CS Bed

The CS Bed is intended for use in an electromagnetic environment in which radiated RF disturbances are controlled. The customer or the user of the CS Bed can help prevent electromagnetic interference by maintaining a minimum distance between portable and mobile RF communications equipment (transmitters) and the CS Bed as recommended below, according to the maximum output power of the communications equipment.

Rated maximum output power of transmitter W	Separation distance according to frequency of transmitter m		
	150 kHz to 80 MHz $d=1.2 \sqrt{P}$	80 MHz to 800 MHz $d=1.2 \sqrt{P}$	800 MHz to 2,5 GHz $d=2.3 \sqrt{P}$
0.01	.12	.12	.23
0.1	.38	.38	.73
1	1.2	1.2	2.3
10	3.8	3.8	7.3
100	12	12	23

For transmitters rated at a maximum output power not listed above, the recommended separation distance d in metres (m) can be estimated using the equation applicable to the frequency of the transmitter, where P is the maximum output power rating of the transmitter in watts (W) according to the transmitter manufacturer.

NOTE 1 At 80 MHz and 800 MHz, the separation distance for the higher frequency range applies.

NOTE 2 These guidelines may not apply in all situations. Electromagnetic propagation is affected by absorption and reflection from structures, objects and people.

4 PRODUCT LABELING

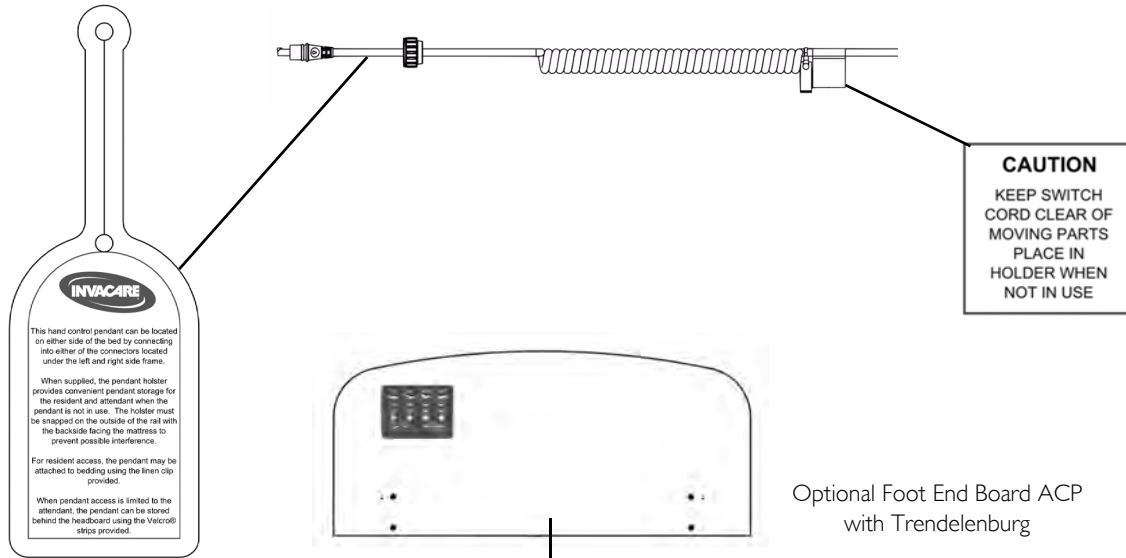

This hand control pendant can be located on either side of the bed by connecting into either of the connectors located under the left and right side frame.

When supplied, the pendant holster provides convenient pendant storage for the resident and attendant when the pendant is not in use. The holster must be snapped on the outside of the rail with the backside facing the mattress to prevent possible interference.

For resident access, the pendant may be attached to bedding using the linen clip provided.

When pendant access is limited to the attendant, the pendant can be stored behind the headboard using the Velcro® strips provided.

CAUTION
KEEP SWITCH
CORD CLEAR OF
MOVING PARTS
PLACE IN
HOLDER WHEN
NOT IN USE

Optional Foot End Board ACP
with Trendelenburg

<p>ATTENTION ⚠</p> <p>Risque d'écrasement lors de l'utilisation de Trendelenburg inversée. Un point de pincement existe entre le pied de lit et la terre à la position plus basse. L'abaissement du pied de lit peut causer des blessures à soi-même ou à autrui. Ne PAS placer les pieds, jambes ou bras dans la zone d'écrasement située sous le pied de lit. Se reporter au Manuel d'Utilisation avant d'utiliser le lit.</p>	<p>115882</p>	<p>CAUTION ⚠</p> <p>Crush Hazard when using Reverse Trendelenburg. Pinch point exists between the Footboard and the floor at the lowest position. Lowering of the foot end may cause injury to oneself or others. Do not place feet or limbs in the crush zone located beneath the Footboard. Refer to the Product Manual prior to operating the bed.</p>
---	---------------	--

5 Technical Data

5.1 Typical Product Parameters

Certifications

All models (120 V~ models - CS3, CS5, CS7, CS9, CS9FX600 and 230 V~ models - CS5, CS7, CS9) conform to UL60601-1 and IEC60601-1. Certified to IEC60601-2-38 and IEC60601-1-2 and CAN/CSA C22.2 No. 601.1. 230 V~ models - CS5 and CS7 are CE marked for Australia and New Zealand.

Elevation Range (floor to deck)

	CS3	CS5	CS7	CS9	CS9FX600
Stability Range (casters locked or off casters)	8¼ to 26½ in (211 to 686 mm)	9 to 30 in (229 to 762 mm)	7 to 30 in (178 to 762 mm)	9 to 30 in (229 to 762 mm)	
Mobility range (on casters)	8¼ in (211 mm) only				
Angle between back section (head deck) and deck platform	0° to 70°				
Angle between back section and upper leg section	>90°				
Trendelenburg or reverse trendelenburg (when configured)	not available		0° to 14° (Optional)		
Under-bed clearance for $\frac{2}{3}$ of bed - centered	14 in (356 mm)				

5 TECHNICAL DATA

Electrical Specifications

	CS3	CS5	CS7	CS9	CS9FX600
Control box mains voltage	120V~	120V~ or 230V~	120V~ or 230V~	120V~ or 230V~	120V~
Control box input current	3.5A max	3.5A max (1.5A max for 230V~ models)	3.5A max (1.5A max for 230V~ models)	3.5A max (1.5A max for 230V~ models)	3.5A max
Control box current frequency	60 Hz	60 Hz (50 Hz for 230 V models)	60 Hz (50 Hz for 230 V models)	60 Hz (50 Hz for 230 V models)	60 Hz
Control box output voltage	24 VDC (70W max)				
Control box duty cycle	10% Max (2 min ON 18 min OFF)				
Motorized linear head actuator	24 Volts DC				
Motorized linear actuators (head, foot, and HI/LO)	24 Volts DC				
Six button hand pendant	standard		not available		
Eight button hand pendant with contour function	not available		standard (10 button optional)		
Attendant control panel (ACP)	optional				
Trendelenburg ACP	not available		optional		

Safety Features

	CS3	CS5	CS7	CS9	CS9FX600
Protective earth ground	Class I				
Electric shock protection	Type B				
Enclosure protection	IPX4				
Floor lock	not available	Optional	standard		
CPR release on head actuator	not available		optional		
Built-in battery back-up	not available		optional (standard with Trendelenburg 24V DC 9.2 Amps)		

Security - Pendant Lock-Out

	CS3	CS5	CS7	CS9	CS9FX600
Pendant connection from either side of bed	standard				
ACL (attendant control lock-out) pendant HI/LO function lock-out	optional				
Individual pendant function lock-out on ACP	optional				

5 TECHNICAL DATA

Dimensions and Weight

	CS3	CS5	CS7	CS9	CS9FX600
Length (overall)					
76 in and 80 in CS Beds			84¼ in (2140 mm)		
80 in CS Bed with 4 in Extension			88¼ in (2242 mm)		
Length between head and foot ends					
76 in CS Bed			78½ in (1994 mm)		
80 in CS Bed			82½ in (2096 mm)		
80 in CS Bed with 4 in Extension			86½ in (2197 mm)		
Length, mattress platform					
76 in CS Bed			76 in (1930 mm)		
80 in CS Bed			80 in (2032 mm)		
80 in CS Bed with 4 in Extension			84 in (2134 mm)		
Width, mattress platform					
36 in Standard Deck			35½ in (901 mm)		
39 in Wide Deck			38½ in (978 mm)		
42 in Wide Deck			41½ in (1054 mm)		
Width with assist rails - 36 in standard deck			39¼ in (997 mm)		

5 TECHNICAL DATA

	CS3	CS5	CS7	CS9	CS9FX600
Width with Thinksoft® positioning devices					
36 in Standard	41¼ in (1048 mm)				
39 in Wide	44¼ in (1124 mm)				
42 in Wide	47¼ in (1200 mm)				
Weight					
36 in Standard Deck	186 lb (84 kg)	190 lb (86 kg)			not available
39 in Wide Deck	196 lb (89 kg)	200 lb (91 kg)			not available
42 in Wide Deck	199 lb (90 kg)	203 lb (92 kg)			not available
CS9FX600 Adjustable Deck	N/A				206 lb
Load capacity - safe working load	450 lb (204 kg)	500 lb (227 kg)			600 lb (272 kg)
4 in bed length extension	optional			optional	
39 in or 42 wide bed deck	optional Not compatible with 68 inch rail.				not available
Adjustable Deck	Not Available				Standard Not compatible with 68 inch rail

5 TECHNICAL DATA

5.2 Mattress Specifications



WARNING

Possible patient ENTRAPMENT Hazard if using non-specified mattress.

Refer to the **Bed Rail Entrapment Risk Notification Guide** at www.invacare.com.

Use only a mattress of recommended specifications with this bed.

A mattress may not be included with this bed. It is highly recommended that you use an Invacare branded mattress that is designed to conform to the following dimensions:

	Named Size	Minimum Size	Maximum Size
Length	76 in (1930.4 mm)	75 in (1905 mm)	76 in (1930.4 mm)
	80 in (2032 mm)	79 in (2006.6 mm)	80 in (2032 mm)
	84 in (2133.6 mm)	83 in (2108.6 mm)	84 in (2133.6 mm)
Width	36 in (914 mm)	35.5 in (911 mm)	36.5 in (927 mm)
	39 in (991 mm)	38.5 in (978 mm)	39.5 in (1004 mm)
	42 in (1067 mm)	41.5 in (1054 mm)	42.5 in (1080 mm)
Thickness	6 in (152 mm)	5.88 in (149 mm)	6.12 in (155 mm)

6 Set-Up

6.1 Unpacking Instructions



CAUTION

Equipment DAMAGE may result from improper wire tie removal.

DO NOT cut any trimmed plastic wire ties. Cut only the untrimmed plastic ties around the wood spacer. All other plastic ties are used to secure the electric cables in place and should not be cut.

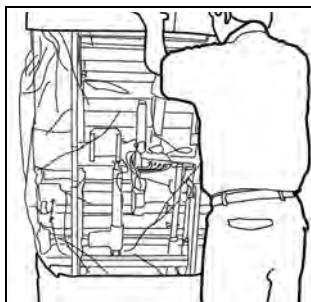

1. Steady upright bed.



2. Slowly lower to floor - use two people if necessary.

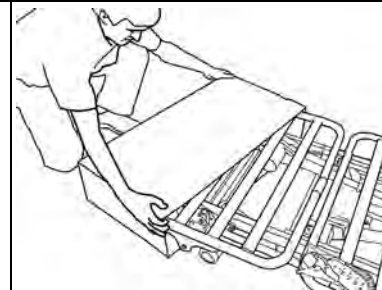

3. Slide off end boxes and remove plastic sleeve.

6 SET-UP



WARNING

Bed DAMAGE or personal INJURY may occur if the bed is dropped.

Ensure the bed is lowered slowly to the floor. Use additional people, if necessary.

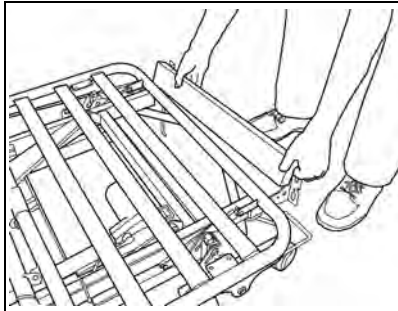

4. Remove wood spacer from front end of bed by lifting it off of bed end brackets.

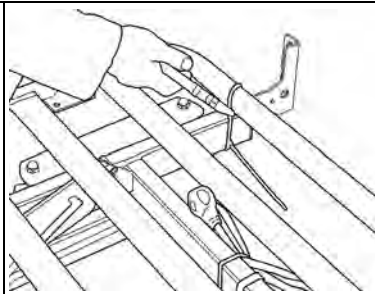

5. Cut the untrimmed or green tie holding the head deck to the frame.

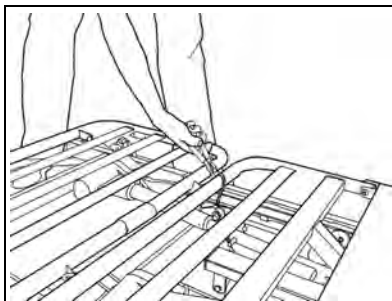

6. Cut the untrimmed or green plastic tie holding the knee-foot panel to the frame.

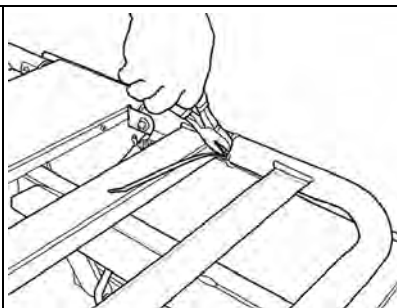

7. Cut the untrimmed or green tie holding the mattress keepers on either side of the bed.

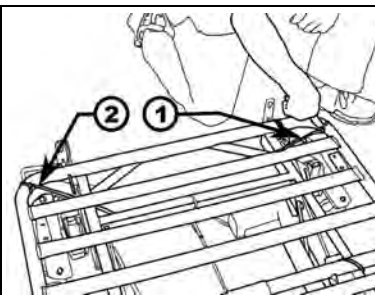

8. Cut the untrimmed or green ties holding the mattress keepers at the end of the bed.

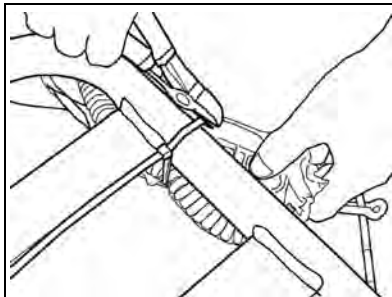

9. Carefully cut the untrimmed or green tie holding the pendant bundle.

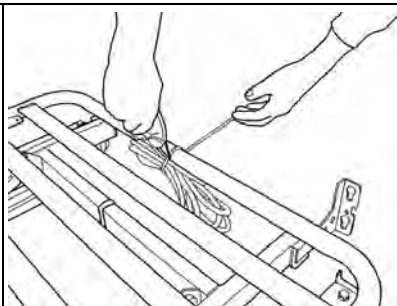

10. Carefully cut the untrimmed or green tie holding the mains cable bundle.

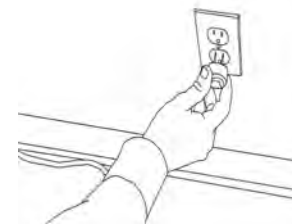

11. Plug power cord into a properly grounded outlet.

6 SET-UP



1. Cut the untrimmed or green tie while holding the wall bumper.



2. Press HI/LO UP button on the hand pendant.

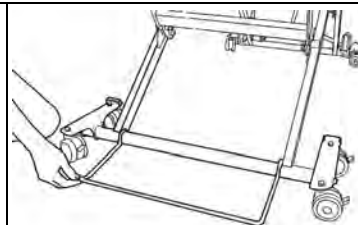

3. Rotate the wall bumper to the floor at the head end of the bed.

6.2 Assembly Instructions

Install the Mattress Keeper Rod to the Head and Foot Decks



WARNING

The mattress keeper rods are an integral part of the bed rail system. By securing the mattress in place, the mattress keeper rods prevent unsafe gaps from forming between the bed ends or rails and the mattress. Install the mattress keeper rods correctly to decrease the risk of patient entrapment.

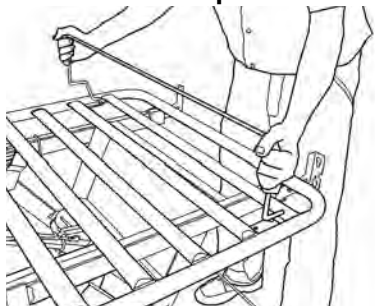
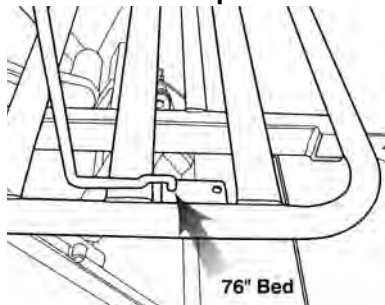
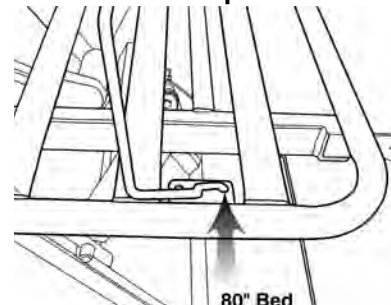
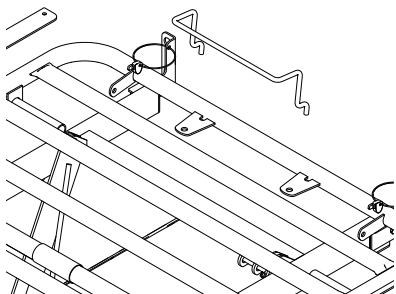
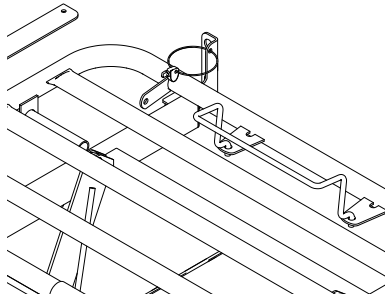
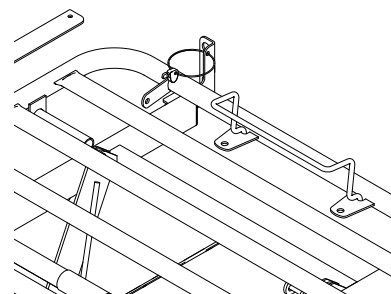

The mattress keeper rods hold the mattress in place. Install them in the head and foot decks.

All Models Except CS9FX600**All Models Except CS9FX600****All Models Except CS9FX600****Model CS9FX600****Model CS9FX600****Model CS9FX600**

1. With the mattress keeper upright, insert the rod ends into the appropriate deck holes.
2. There are two choices for mattress keeper rod insertion. (76 in bed option shown above)
3. Mattress keeper rod insertion on 80 in Bed.

6 SET-UP

All Models Except CS9FX600



Model CS9FX600

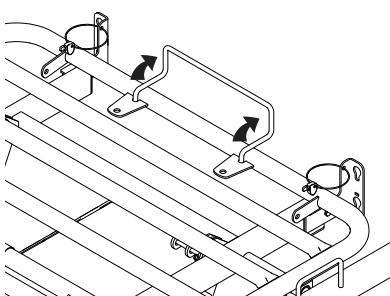

4. Fold the mattress keeper around the bed in the rod. The mattress keepers should rest flat on the foot deck and the head deck.

80 in bed position shown.

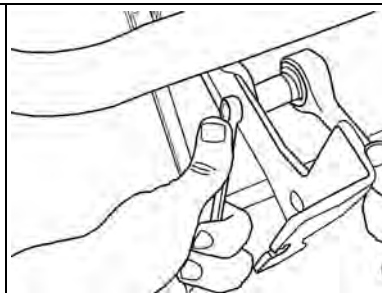

5. 76 in Bed Only - With a 7/16 in socket wrench and 7/16 in wrench loosen and remove the bed end bracket fasteners.

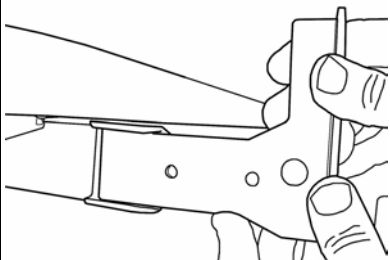

6. 76 in Bed Only - Remove the fasteners on the bed end bracket.

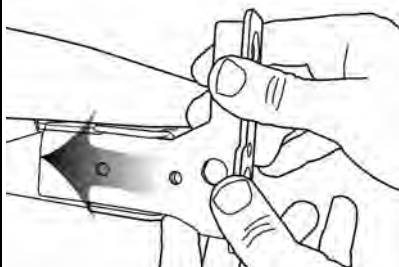

7. 76 in Bed Only - Slide the bed end bracket in the mounting channel. Align the hole in the bracket with the channel hole.

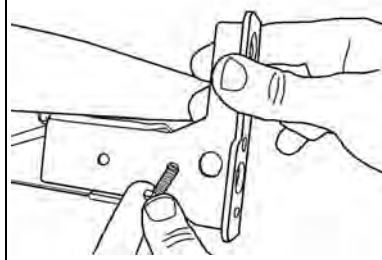

8. 76 in Bed Only - Reinsert the bed end bracket fasteners.

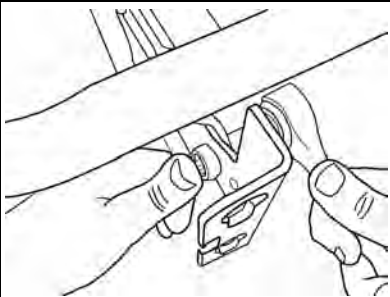
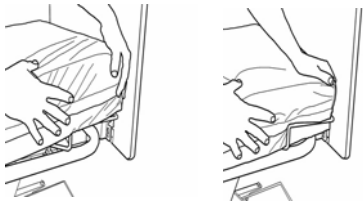
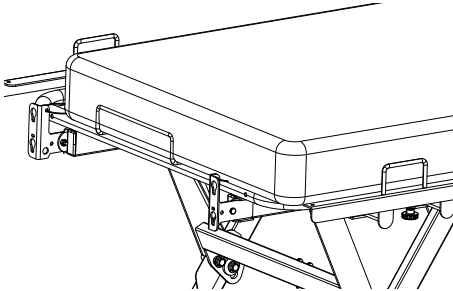
	<p>All Models Except CS9FX600</p> 	<p>Model CS9FX600</p> 
<p>9. 76 in Bed Only - Tighten the fasteners with two 7/16 in wrenches. Reposition the other three brackets and reapply the ends.</p>	<p>10. Position the mattress on the deck. 11. Press the mattress inside the mattress keeper. Ensure the mattress is engaged on all four corners.</p>	

Install Head and Foot Ends



Head and foot ends are normally packaged together either in a cardboard box or on a wooden skid separate from the bed. Bed end model IHBEADJ must be used with bed model CS9FX600. Refer to [Adjusting the Head Board Width for CS9FX600](#) on page 62.

6 SET-UP

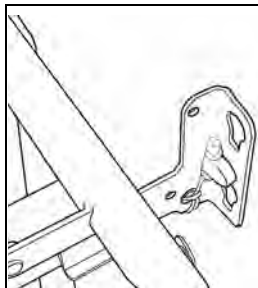

1. Remove the key from the keyhole.

Bed end not shown.

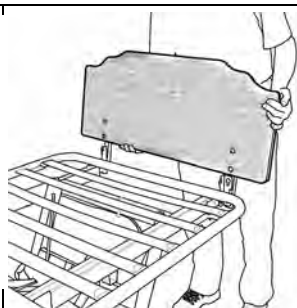

2. Position Head End next to the head board bracket. Hook the head post screws in the bracket slots.

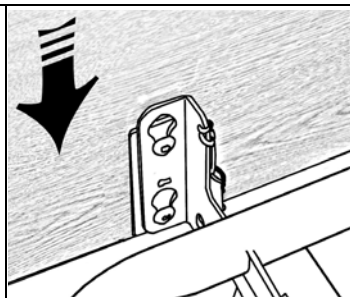

3. Slide the boards down while plate/post screws are in the bracket slots.

Foot end shown.



4. Position Foot End next to the foot board brackets. Hook the board screws into the bracket slots.

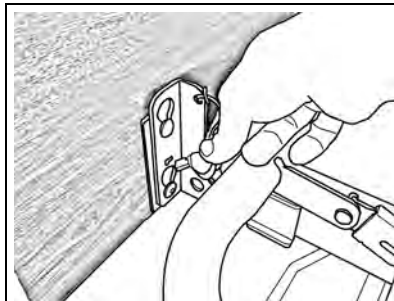

5. Guide the key through the small bracket hole. The key is attached to the bed bracket with a lanyard.

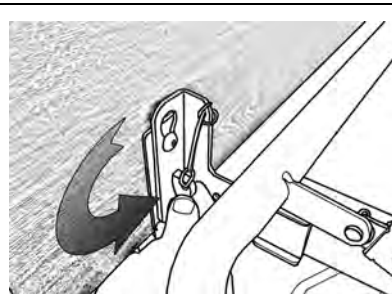

6. Turn and lock the key once it is fully inserted. Repeat on the other side, then the opposite bed end, securing both mounting points on each board.

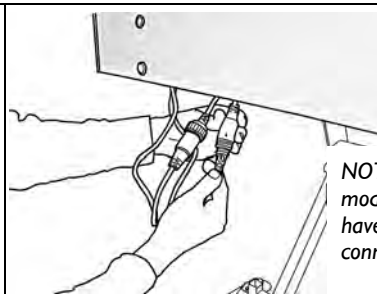

7. Attach the cables from the foot end board to the bed cables (ACP cable and pendant coupling). Tighten the nut*.

**ACP bed only.*

NOTE: Some models only have one connection.

7 Usage

7.1 Hand Control - Pendant Operation



CAUTION

CRUSH Hazard.

DO NOT place feet under the frame when lowering the bed.

3 Function Pendant

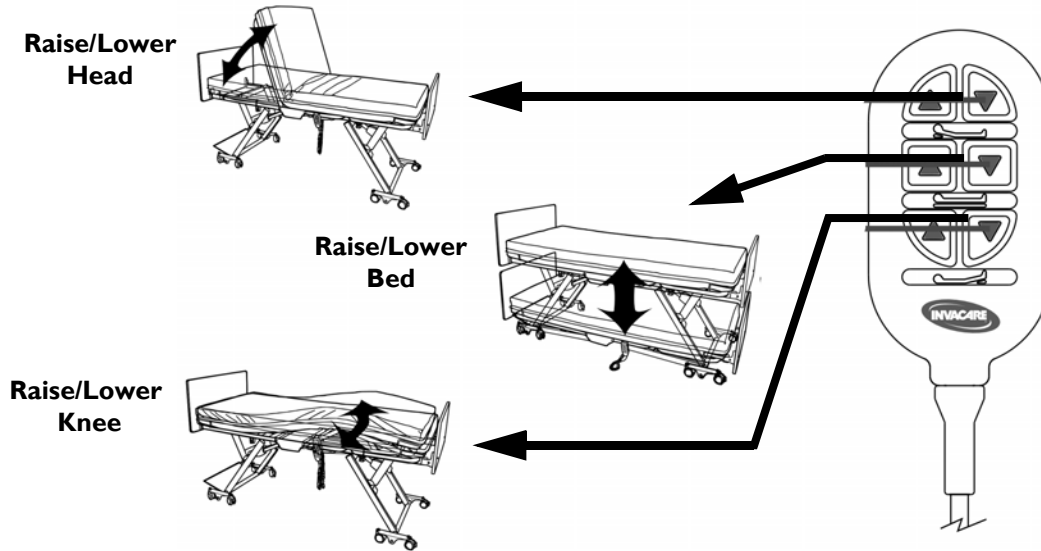

FIGURE I 3 Function Pendant

7 USAGE

4 Function Pendant

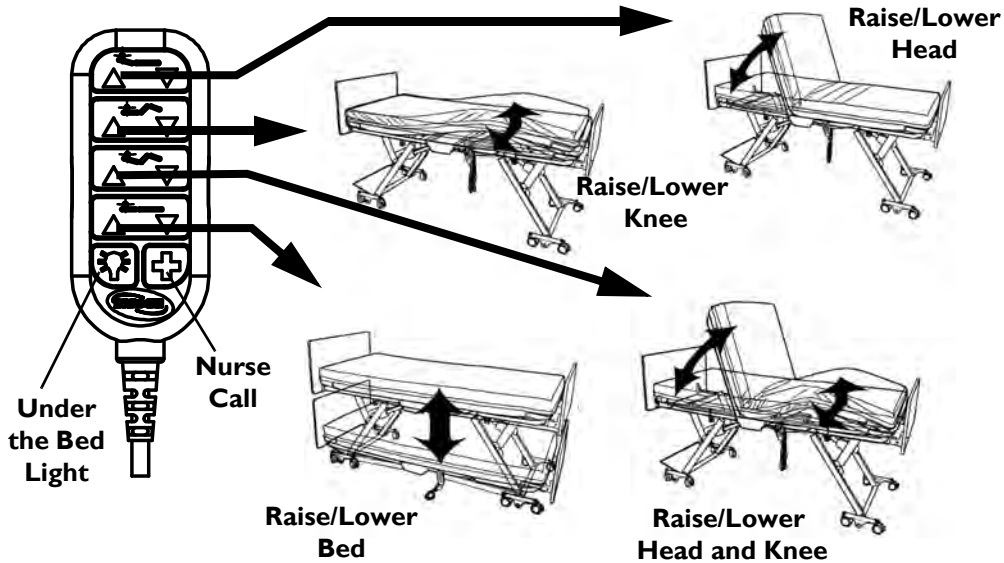
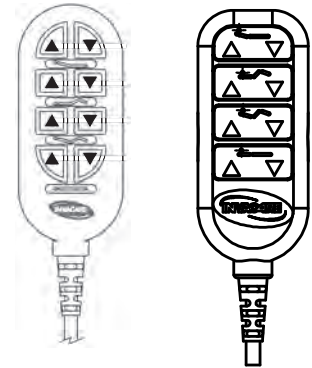

FIGURE 2 4 Function Pendant

Alternate Pendants



7.2 Pendant Storage and Location



DANGER

Electrical SHOCK Hazard.

Before working on any electrical part, such as the 9-pin pendant coupling, ensure the main power to the bed is disconnected and the capacitor inside the control box is fully discharged.

Full capacitor discharge can be achieved by sequentially depressing the 'Up' and 'Down' buttons on the hand pendant at least 20 times after main electrical power to the control box is cut. Ensure the hand pendant is not locked-out when discharging it.

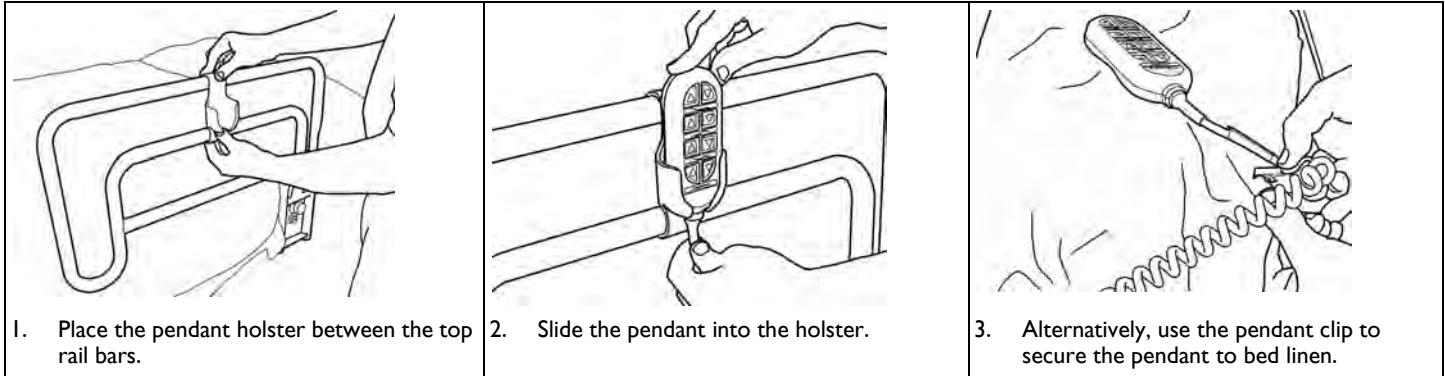

7 USAGE

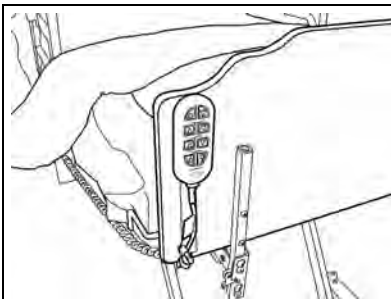

4. The pendant can also be attached to the back of either side of the Head end.

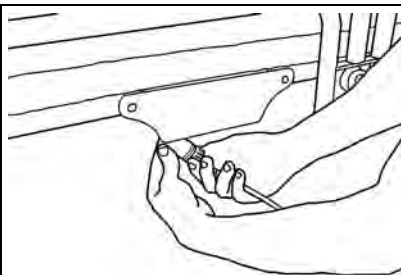

5. To move the pendant to the other side of the bed, disconnect the main power then unscrew the coupling cap on the pendant cable.



6. Remove the cable end from the Y cable housing.

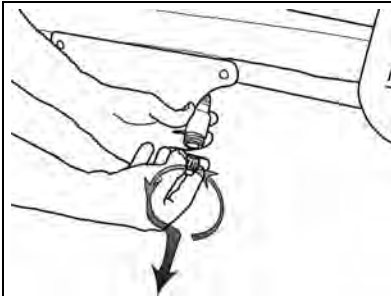

7. On the other side of the bed, remove the cap from the Y cable housing. Replace the cap on the other side of the bed.

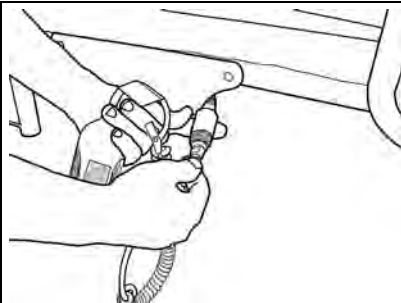

8. Align arrows then insert the pendant cable end into the Y cable housing.

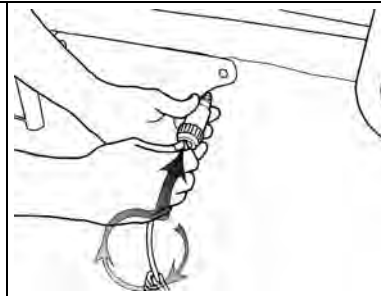

9. Screw the coupling cap to the threaded Y cable housing end.

7.3 Power Cord Storage



Disconnect the main power cable from the wall outlet and store the power cord when the bed is not in use.

1. Secure the power cord to the back of the head end with the hook and loop strap when moving the bed.
2. Excess power cord can be secured to the back of head end with the hook and loop strap.



7 USAGE

7.4 Raise and Lower the Heel Lift Ratchet

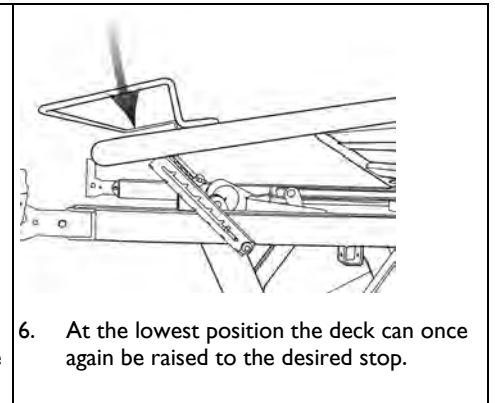
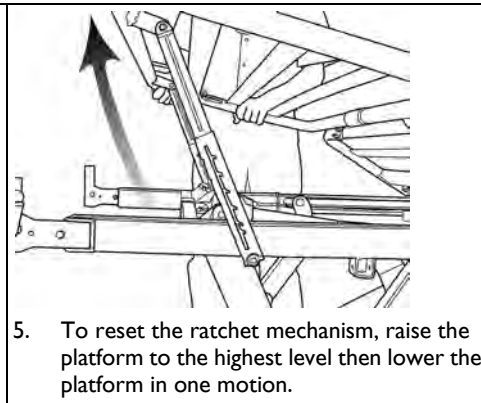
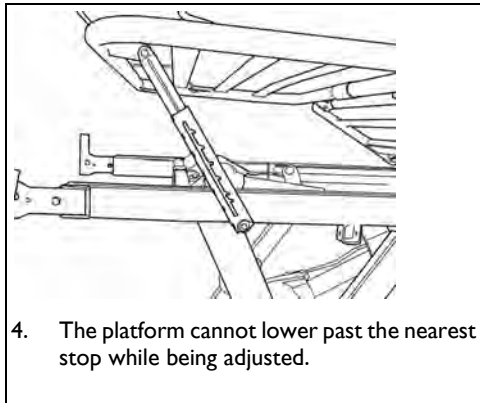
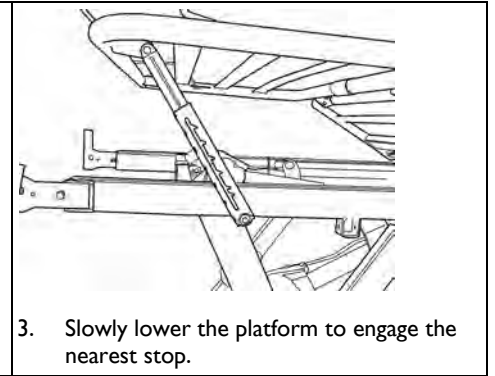
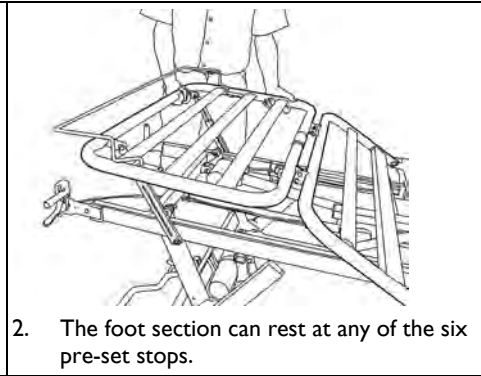
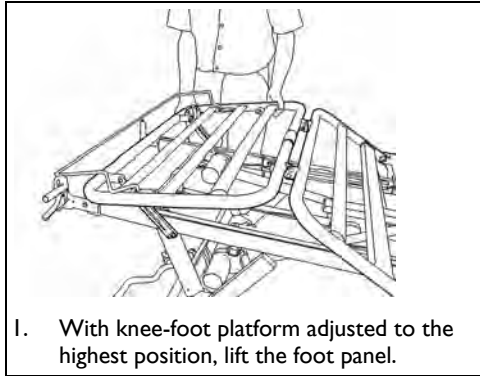

7.5 Foot Pad Lock Mechanism on CS3 Bed



CAUTION

Moving the bed while the floor lock, caster lock, or foot pad is engaged may DAMAGE the bed.
DO NOT move the bed unless the floor lock, caster lock, or foot pad is disengaged (unlocked).

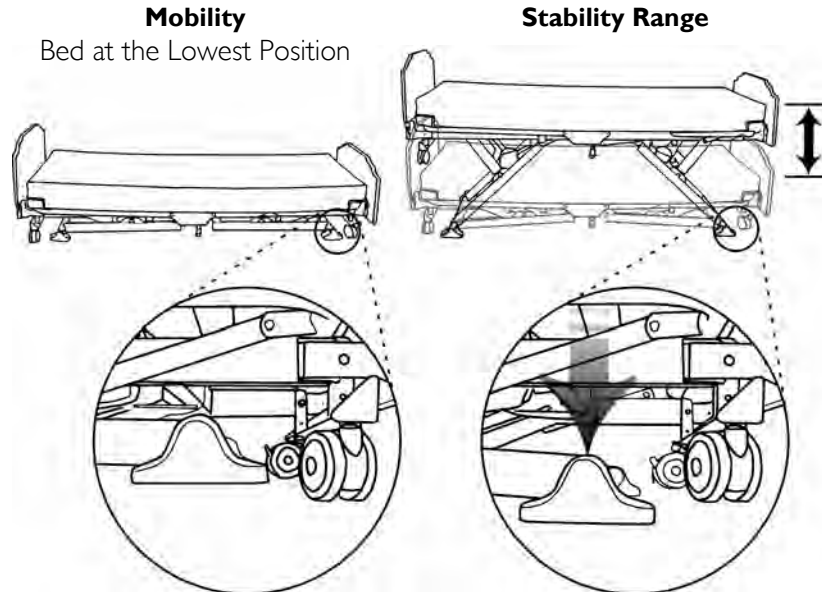
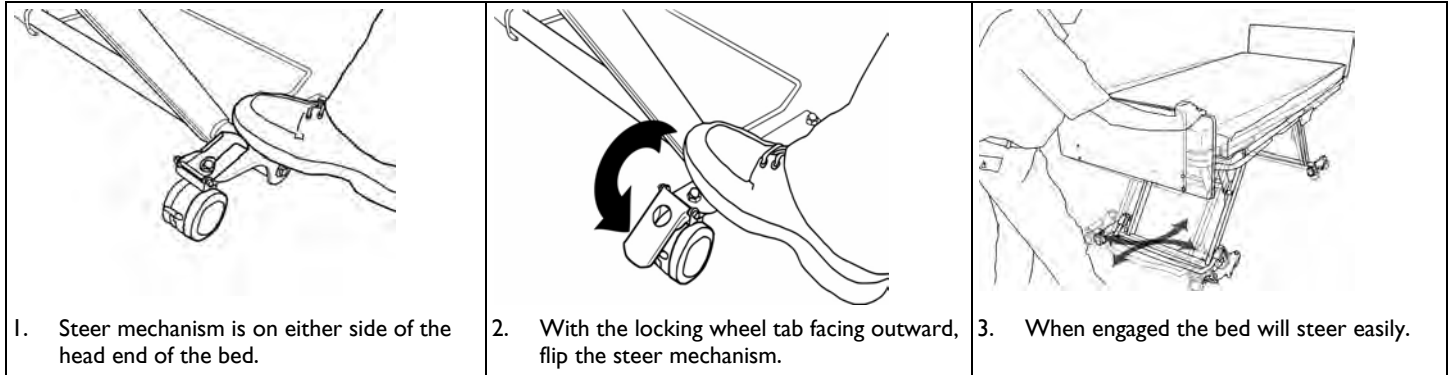

FIGURE 3 Foot Pad Lock Mechanism on CS3 Bed

7 USAGE

7.6 Bed Steer Mechanism



8 Options



WARNING

After ANY adjustment, repair or service and BEFORE use, make sure that all attaching hardware is tightened securely. Failure to tighten hardware securely may result in injury or damage.

8.1 Safety Information For Options



WARNING

Refer to the **Bed Rail Entrapment Risk Notification Guide** at www.invacare.com.

Patient ENTRAPMENT with Assist Rail or Assist Bar may cause injury or death. Mattress must fit snugly within the mattress keepers to prevent patient entrapment. Use only a mattress of recommended specifications with the bed. Monitor patient frequently. Assess the needs of the resident prior to using the Assist Rail or Assist Bar.

Incorrect mounting of the assist rail or assist bar may result in patient entrapment. To reduce the risk of entrapment, mount the assist rail or assist bar as shown in the instructions included with the rails or bars.



Crush Hazard exists between assist Rail or Assist Bar and Floor at the lowest bed position. Lowering the bed may cause INJURY to oneself or others.

Lockout the Hand Control when working near the bed and DO NOT place feet or limbs in the crush zone located beneath the Assist Rail or Assist Bar.

**WARNING**

Patient entrapment with bed rails/assist devices or 68 Inch Rail may cause injury or death. Mattress must fit snugly within the mattress keepers to prevent patient entrapment. Use only a mattress of recommended specifications with the bed. Monitor patient frequently. Assess the needs of the resident prior to using the bed rails/assist devices.

Incorrect mounting of the bed rails and assist devices or 68 Inch Rail may result in PATIENT ENTRAPMENT. To reduce the risk of entrapment, mount the bed rails/assist devices or 68 Inch Rail as shown in the instructions.

When a PATIENT'S condition (such as disorientation due to medical or clinical conditions) could lead to Patient Entrapment, the mattress support platform should be left in the flat position while unattended (except when required otherwise by medical staff for special or particular circumstances).

Use of incompatible trapeze units may cause injury and/or damage. Use only Invacare trapeze systems designed specially for the CS bed: Standard Trapeze (1153385) or Heavy Duty Trapeze (1153386).

Use of trapeze may be hazardous to residents or guests. Possible entanglement may result from improper use of trapeze. Evaluate residents prior to allowing them to use a trapeze. Never allow children to use, play, or swing on the trapeze.

The Standard and Heavy Duty Trapeze are designed to provide support, increased stability and assist the user when repositioning himself/herself in bed. The Standard and Heavy Duty Trapeze are NOT designed, however, to support the total body weight of an individual. Use it for assistance ONLY.

Tipping hazard. When in use, always rotate the trapeze until the handle is located over the center of the bed and ensure that it drops down into the anti-rotation position.

Improper mattress placement may result in PATIENT ENTRAPMENT.

To ensure FDA Rail Guidelines are met, use ONLY the 84 inch CS bed kit with a mattress that is 84 inch (2137 mm) long. An 80 inch mattress with a 4 inch extension pad MUST NOT be used in any circumstance. Mattress MUST fit bed frame and assist rails snugly to reduce the risk of entrapment.



WARNING

Safe Working Load of the Standard Trapeze is 168 lb. (750 N). DO NOT exceed 168 lb. (750 N).

Safe Working Load of Heavy Duty Trapeze is 250 lbs. (1115 N). DO NOT exceed 250 lb. (1115 N).



A PINCH / SQUEEZE point exists between the head deck and the side rails.

To avoid INJURY keep arms and other appendages away from the openings in the side rails and the upward moving head deck.



CAUTION

Contact between the floor and the Assist Rail may cause the bed to become UNSTABLE.

An unstable bed may tilt from horizontal and / or drop suddenly causing property DAMAGE or personal INJURY. Before lowering the bed, ensure the Assist Rail is NOT in the TRANSFER position. INJURY from patient falls may occur even when operating the side rails as instructed. Place the bed in the lowest position to minimize the risk from falls.

The trapeze bar may damage walls and ceilings when used with the Trendelenburg feature. Invacare recommends removing the trapeze when using the Trendelenburg function.

DO NOT install an 84 Inch CS Bed kit on a bed that is equipped with the CPR release feature.

DO NOT install an 84 Inch CS Bed kit on a bed that is equipped with the Trendelenburg and Reverse Trendelenburg feature.



Risk of FALL when Assist Bar is UNLATCHED. Assist Bar may rotate quickly and drop to the next locked position causing the patient to lose their balance and fall. Ensure the Assist Bar is fully latched in down position after each use. Check that the Assist Bar is locked before leaving a patient unattended. Never use the Assist Bar as a Rail.



If necessary, the head and foot end board position can be adjusted in order to meet FDA guidelines. Refer to the section titled, "Install the Mattress Keeper Rod to the Head and Foot Decks" for detailed instructions on adjusting the end board bracket location.

8 OPTIONS

8.2 Bed Rails and Positioning Devices

The listed bed rails and positioning devices are available:

MODEL	DESCRIPTION
IHCSRLAS	CS Assist Rails - Set
IHCSRLAS-NG	CS No Guard Assist Rail - Set
IHCSBARS	CS Assist Bar - Set
IHCSTSPD	ThinkSoft® Positioning Device TSPD
IHCSRLPA	68 Inch Rail
IHCSRLAS - 39NG	CS No Guard assist rail for 39 inch wide deck - set
IHCSRLAS - 42NG	CS No Guard assist rail for 42 inch wide deck - set
IHCSBARS - 39	CS assist bar for 39 inch wide deck - set
IHCSBARS - 42	CS assist bar for 42 inch wide deck - set

8.3 Other Accessories

The listed items are available as optional accessories:

MODEL	DESCRIPTION
IHCSBEK	4 Inch Extension Kit
IHCSDB	Drainage Bag Holder
IHCSTRP	Standard Trapeze and Mounting Bracket
IHCSTRPHD	Heavy Duty Trapeze and Mounting Bracket
IHCSPD	Aftermarket Pan Deck Kit

8.4 Optional Drainage Bag Holder

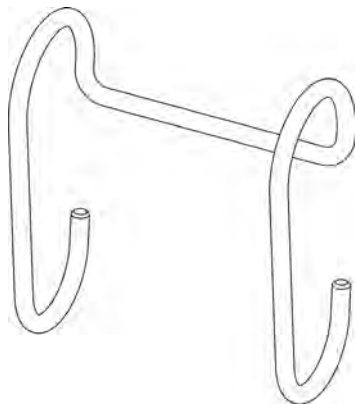

8.5 Optional Touch-up Paint

Sherwin-Williams®

5A-58147 00(A)

CODE 82X

WHITE BIRCH

2nd Dimension 5.0 Acrylic Enamel

This product can be purchased at Sherwin Williams Automotive paint branches only.

8 OPTIONS

8.6 Optional Attendant Control Panel Operation

3 Function Pendant

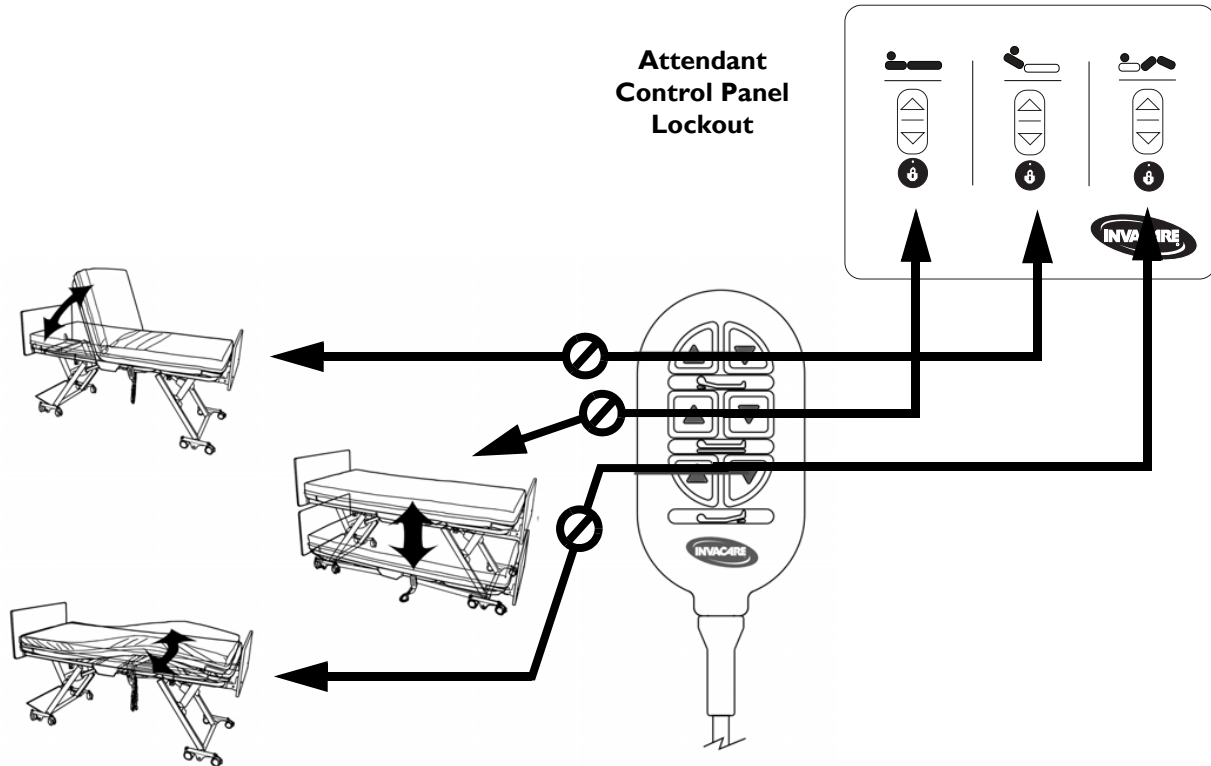

FIGURE I 3 Function Pendant

4 Function Pendant

Using the integrated Nurse Call Feature

1. Locate call cord cable at the head of the bed along with the power cord.
2. Route cable to nurse call wall outlet and insert call cable plug into socket.



WARNING

Extra cable should be routed and secured to bed to prevent tripping hazards. Otherwise injury may occur.

CAUTION

Route cable and secure to bed avoiding all pinch points. Otherwise damage to the cable and bed will occur.

3. Coil any extra cable and secure to the bed.
4. Test Nurse Call by pressing the red first aid button on the hand pendant.



In the event of a power failure or an issue occurs within the electronic system of your Invacare bed, the nurse call button will be activated, and will not be reset until the electronic system is running properly. Remove the nurse call plug to disable nurse call signal until service is preformed.

Using the Underbed Light

1. The underbed light has pre-installed at the foot end of the bed. All cabling has been routed and secured to keep it from getting pinched during normal operation of the bed.

8 OPTIONS

The underbed light can be turned on by pressing the blue light button on the hand pendant. Press again to turn off.

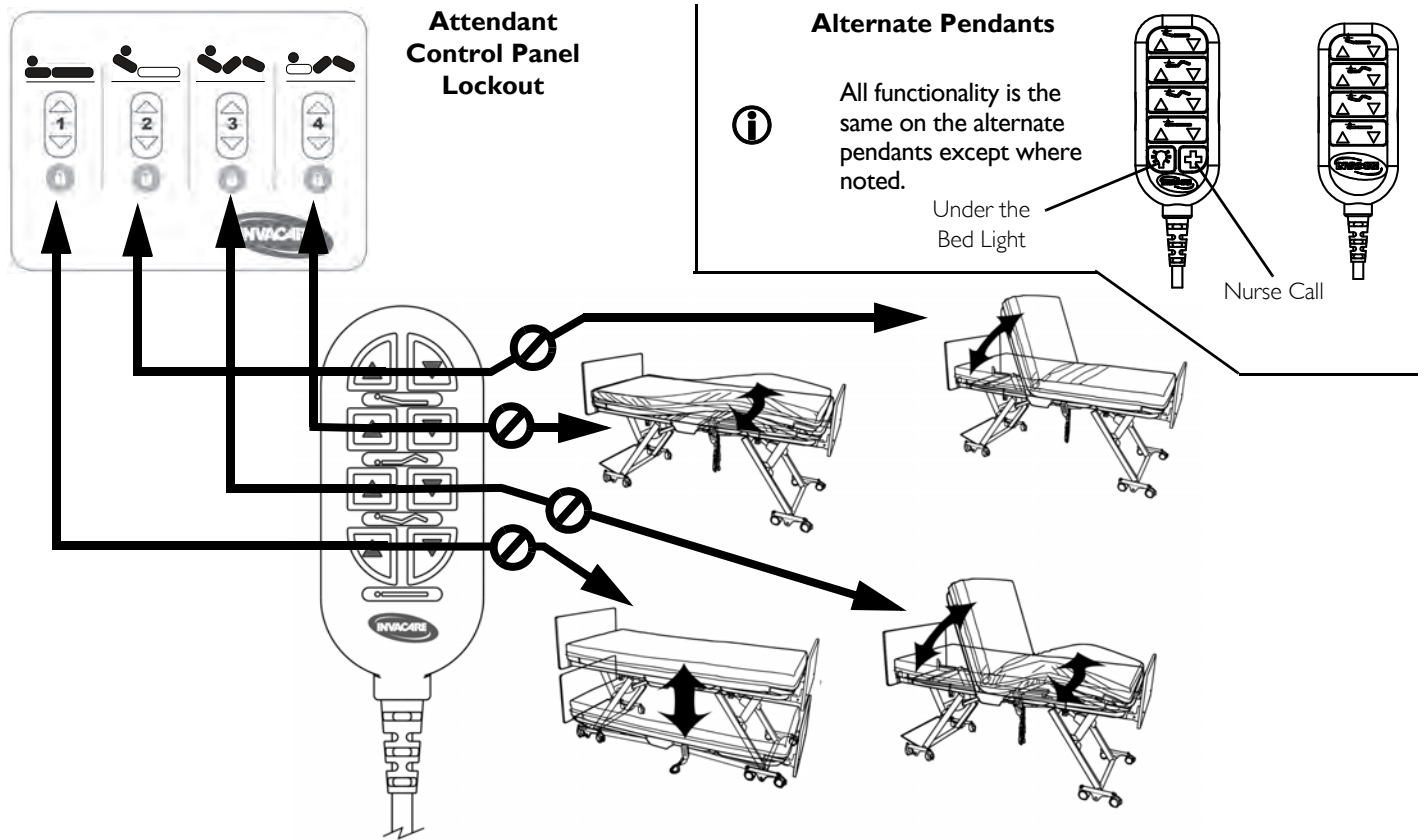

FIGURE 2 4 Function Pendant

8.7 Optional Trendelenburg and Reverse Trendelenburg Attendant Control Panel

**CAUTION**

Use of Trendelenburg or Reverse Trendelenburg feature may not be appropriate for certain patients. Trendelenburg and Reverse Trendelenburg should only be used on the advice of a medical practitioner.

DO NOT install a CS Bed Extender on a bed that is equipped with the Trendelenburg and Reverse Trendelenburg feature.

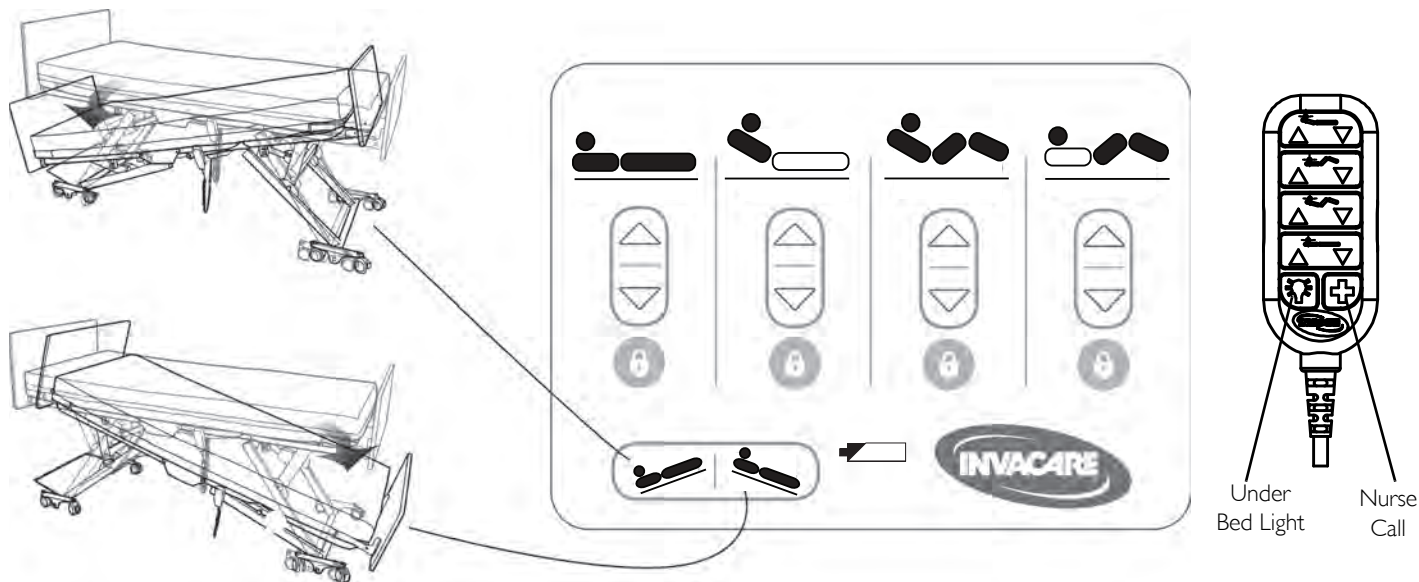

FIGURE 3 Optional Trendelenburg and Reverse Trendelenburg Attendant Control Panel

8 OPTIONS

8.8 Pendant HI/LO Lock Out - Optional



When in the “OFF” position, the HI/LO function on the pendant will NOT operate. When in the “ON” position, all pendant functions will operate normally. The head function and knee-foot function on the pendant remains operational whether the lock out is activated or deactivated.

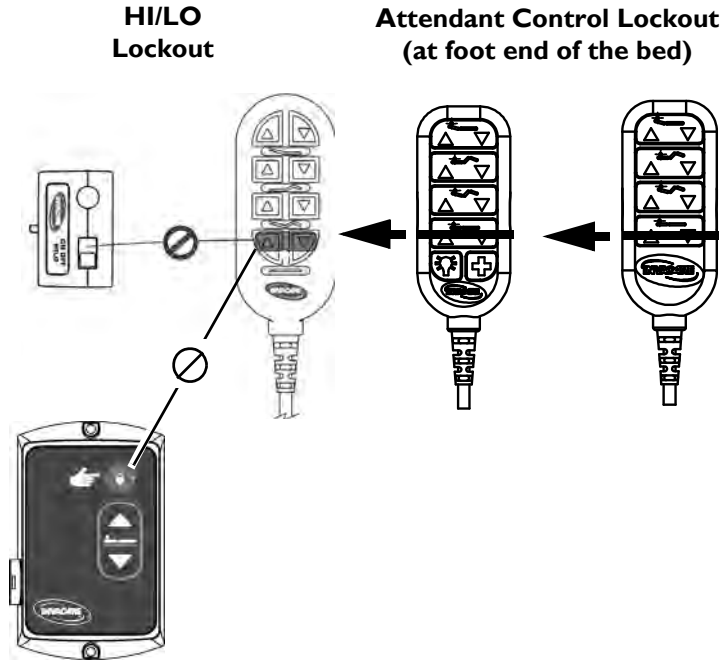

FIGURE 4 Pendant HI/LO Lock Out - Optional

8.9 Optional Cardiopulmonary Resuscitation (CPR) Release



CAUTION

Activation of the CPR release may cause attendant or resident injury. Use with Caution.

Use the CPR release only for emergency situations. This function will rapidly bring the head deck to a flat position. Two-person operation is recommended; one person to release the head deck, and another to hold and gently guide the head deck down.

DO NOT install a CS Bed Extender on a bed that is equipped with the CPR release feature.



PINCH-POINT between rail and floor is created when lowering bed to the lowest position.

Keep feet clear of bed rail when lowering bed.

Close supervision is necessary when this product is used by or near children or people with disabilities. DO NOT let any individual underneath the bed or in between the raised bed frame components at anytime.

Using the CPR Release

When using the CPR Release function, it is recommended to use two people; one person to release the head deck at the foot end of the bed and another person to gently guide the head deck to a horizontal position.

Additional Means to Lower the Back Rest in an Emergency

The clevis pin and retaining clip can be removed from the connection between the head actuator and head deck section to lower it. The head deck must be supported while removing the pin and lowering the head deck.

8 OPTIONS

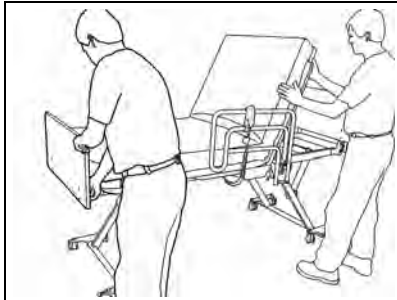

1. CPR handle is at the foot of the bed. A second person is recommended to gently lower the head deck.

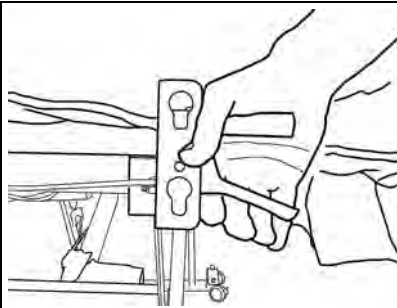

2. Grip the CPR handle (at the foot end of bed).
Foot end not shown for clarity.

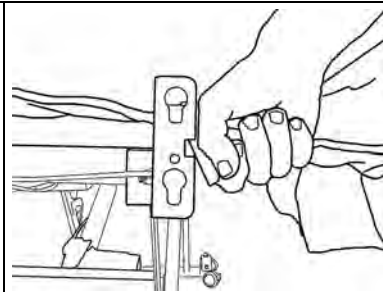

3. Squeeze the CPR handle to drop the head deck.

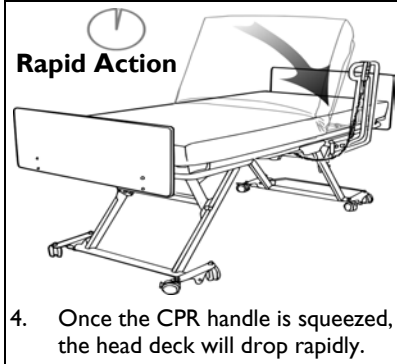

4. Once the CPR handle is squeezed, the head deck will drop rapidly.

8.10 Optional 39 Inch and 42 Inch Wide Decks



WARNING

Possible patient ENTRAPMENT Hazard if using non-specified mattress on a wide bed. Mattress must fit snugly between appropriate mattress keepers and properly sized head and foot ends that are designed for use on wide beds. Use only a mattress of recommended specifications with this bed. DO NOT use a mattress extension pad. Refer to [Technical Data](#) on page 23.



The following bed options are not compatible with the 39 inch or 42 inch wide bed deck: 68 inch rail.

The CS bed is available with wider decks for resident comfort. Both 39 inch wide deck and 42 inch wide decks are factory installed options.

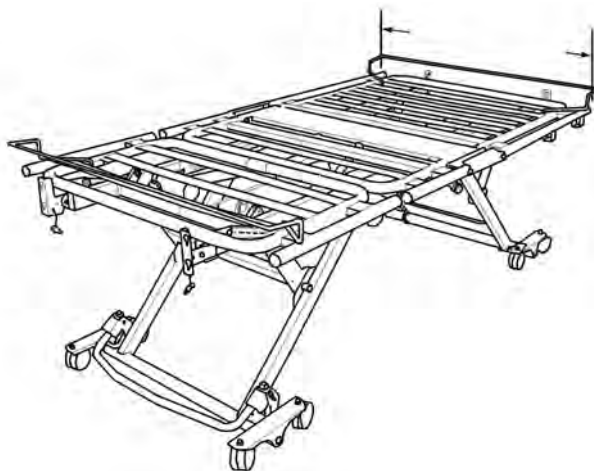

**39 in or 42 in
Nominal**

FIGURE 5 Optional 39 Inch and 42 Inch Wide Decks

8 OPTIONS

8.11 Adjustable Width Bed Model CS9FX600



WARNING

Possible patient ENTRAPMENT Hazard if using non-specified mattress on an adjustable bed. Mattress must fit snugly between appropriate mattress keepers and properly sized head and foot ends that are designed for use on wide beds. Use only a mattress of recommended specifications with this bed. DO NOT use a mattress extension pad. Refer to the Bed Specification section in this manual.



The following bed options are not compatible with the CS9FX600: 68 inch rail.

Adjusting the CS9FX600 Bed Width



All eight adjustable deck wings must be adjusted to the same width. Ensure the appropriate bed and head board settings are used as described in this procedure.

The CS9FX600 has eight adjustable deck wings which can be adjusted to 36 in, 39 in or 42 in. The locations of the wings and adjustment knobs are shown in FIGURE 6.

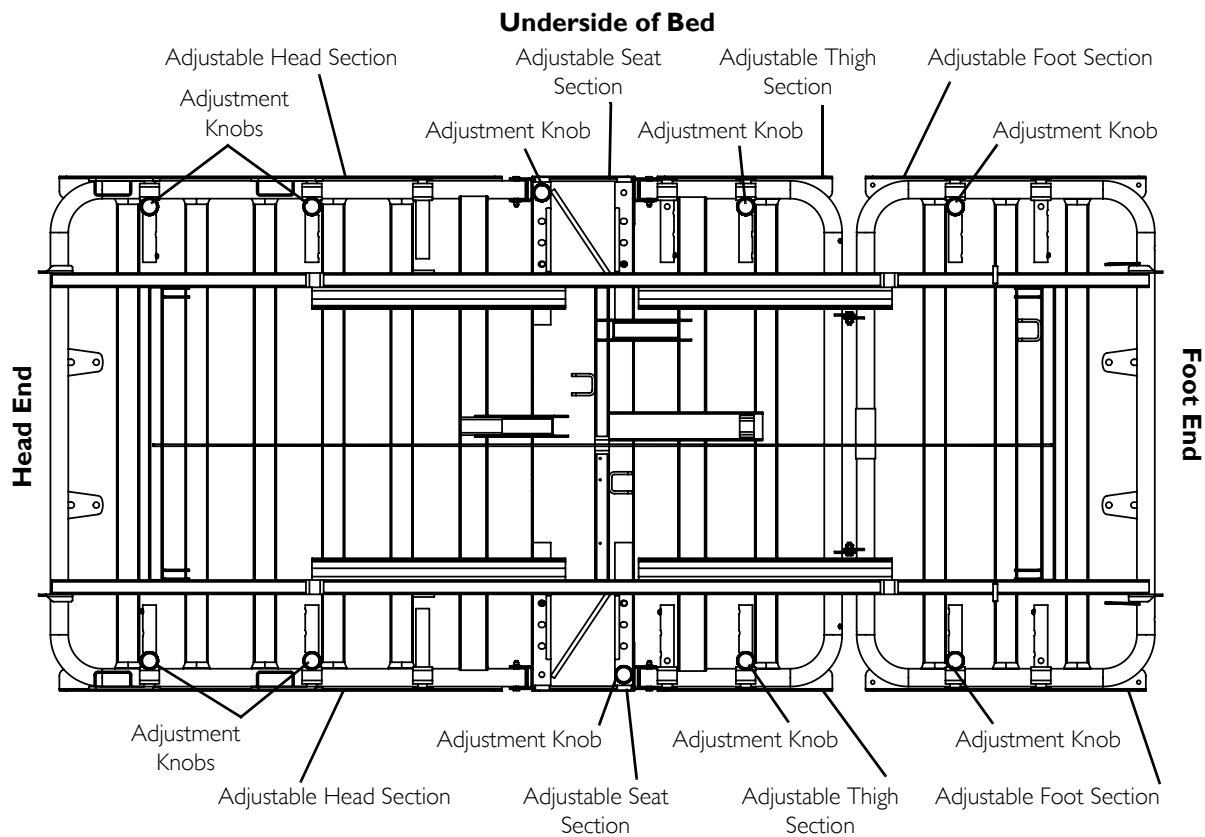
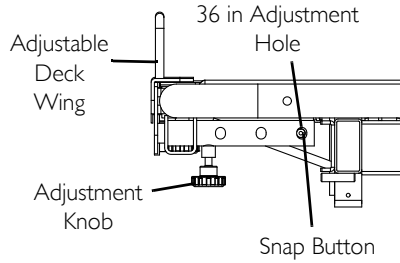

FIGURE 6 Adjustable deck wings, knobs and snap buttons

8 OPTIONS

36 in Width Side View



Top Bed Deck View

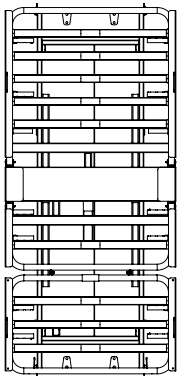

39 in Width Side View

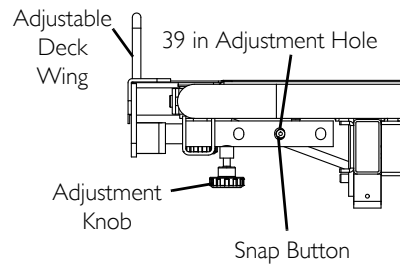

Top Bed Deck View

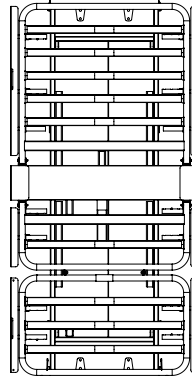

42 in Width Side View

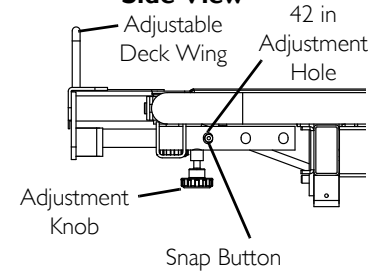

Top Bed Deck View

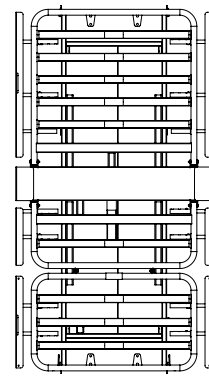

1. Loosen the knob securing the adjustable deck wing.
2. Depress the snap button
3. Slide the adjustable deck wing in or out to the desired position.
4. Ensure the snap button snaps into the appropriate adjustment hole.
5. Tighten the knob to secure the adjustable deck wing.
6. Adjust the head board width. Refer to [Adjusting the Head Board Width for CS9FX600](#) on page 62.
7. Repeat STEPS 1 to 6 for each section until they are all adjusted to the same width.

8 OPTIONS

Adjusting the Head Board Width for CS9FX600

Bed end model IHBEADJ is intended for use on bed model CS9FX600. The head board is adjustable and ships in the position for a 36 in wide bed.

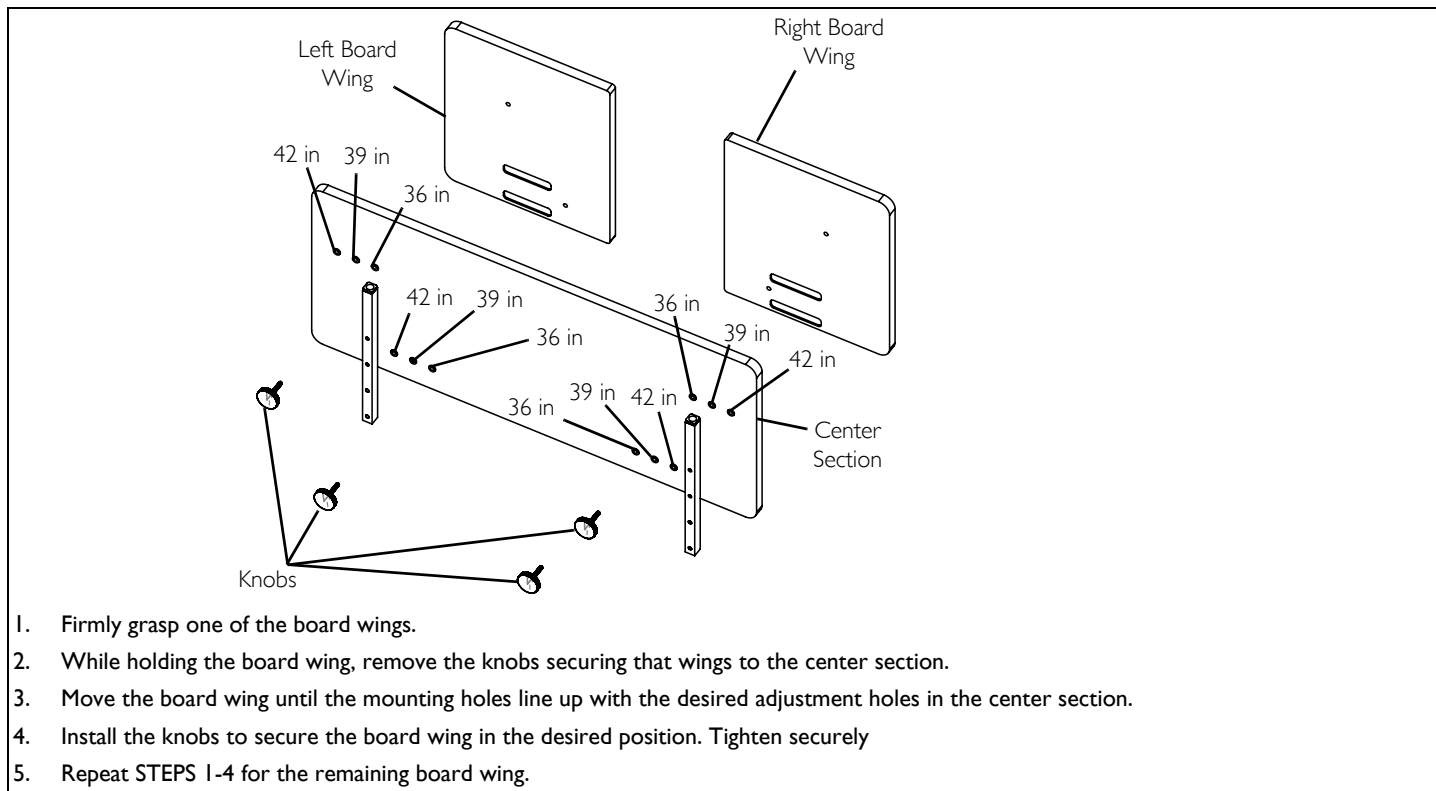

9 Maintenance

9.1 Cleaning Instructions



CAUTION

Equipment or property **DAMAGE** or resident **INJURY** may occur during maintenance.

1. Unplug product before washing.
2. Make sure all electrical parts (motors, control box and pendant) are not damaged and that all connection ports are plugged. **DO NOT** allow liquids to enter electrical components.
3. Disinfect and wash all components. **DO NOT** submerge the bed frame or electrical parts.
4. **DO NOT** power wash or steam-clean. Use household water pressure only.
5. Rinse thoroughly with water (maximum temperature 110°F or 43°C). **DO NOT** use solvents, bleach, alcohol, petroleum products, caustic agents, or highly alkaline or acidic agents to clean the bed.
6. Retract each actuator to the minimum stroke length before washing to avoid degreasing the piston rod.
7. Dry all components before storing.

9 MAINTENANCE

9.2 Annual Maintenance Check



WARNING

Failure to maintain your bed may reduce product life and increase unplanned maintenance.

When evaluating the condition of rail attachments it is necessary to consider all aspects of the bed-rail system, including consideration of the rails, mattress, and bed systems. Refer to the Hospital Bed System Dimensional and Assessment Guidance to Reduce Entrapment published by the U.S. Department of Health and Human Services Food and Drug Administration.

- Inspect the covering of the bed's control panel and the patient control panel to assure that the covering is not cracked or damaged.
- Inspect for damaged or loose wiring. Have a qualified technician replace any frayed or damaged cords.
- Inspect for secure grounding.
- Inspect rail latches. Ensure that all rails engage and lock as specified.
- Inspect rails for wear and damage and replace as required.
- Lubricate rail pivot points as needed with white lithium grease.
- Inspect bed, rails, Assist Rails or Assist Bars for the presence of tubing end caps and replace as required.
- Tighten, adjust or replace any parts or bolts etc. that are loose or show signs of wear.
- Lubricate all mechanical hinge points, bushings, and surface contact points with white lithium grease.
- Inspect for wear on clevis pins and hitch pins and replace if worn or missing.
- Inspect the rails for noticeable scratches and chips. Use a matching enamel touch up paint to retouch if necessary. (Refer to Options for paint specification).

9.3 Quarterly Maintenance Check

- Unplug bed from wall outlet and verify battery function, if equipped. Battery may be built-in or portable.

9.4 Environmental Conditions for Storage and Transport

- Store and/or transport the bed in a clean and dry environment with an ambient temperature range between 10° and 50° Celsius (0° to 125° F).

9.5 Environmental Conditions for Operation

- Bring the bed to a Safe Operating Temperature between 5° and 40° Celsius (41° and 100° F) before operating the bed.

10 Troubleshooting



WARNING

Read all general guidelines, warnings and cautions before performing any repair/maintenance on the bed. All repair and maintenance on the bed should be performed by a qualified technician.

Unplug the power cord from its power source before performing any maintenance on the electric bed. **DO NOT** unplug the power cord from the control box. Damage to cord will result.

EFFECT	POSSIBLE CAUSE	VERIFICATION	CORRECTIVE ACTION
Bed does not stay in place	Floor lock not engaged.	Green plunger on floor lock post is visible.	Activate floor lock - green plunger should NOT be visible.
	Insufficient static friction between floor lock foot bumper and floor.	Floor surface is slippery and/or foreign membrane between bumper and floor.	Clean the surrounding floor and remove loose material under the bed.
	Floor lock not functioning.	Floor lock is stuck in one position.	Contact Invacare Continuing Care Service Department 1-800-668-2337.
Bed is not level	Hi/Lo actuators are unevenly extended	Bed deck is not parallel with floor	Raise bed to highest position or Lower bed to lowest position
Actuator not working.	System Fault Needs Reset	Flashing LEDs on ACP, Bed function will not operate. The control box may beep when pendant function is pressed.	To Reset - hold the pendant bed up and bed down buttons for 5+ seconds. The bed will beep and stop beeping when reset is complete. Then press the bed up button. If the bed beeps, the actuators are out of sync. Continue rising to the highest position to synchronize the actuators.

10 TROUBLESHOOTING

EFFECT	POSSIBLE CAUSE	VERIFICATION	CORRECTIVE ACTION
Actuator not working.	HI/LO lock-out is on.	For non-openbus (CS3, CS5) - A Lockout box (a square black box) with a toggle switch. When the switch is towards "ON" side, the HILO on the hand pendant will not function. There is no LED light.	Rotate the lockout dial to the "unlocked" position (horizontal), or flip switch to OFF.
		For openbus beds (CS7, CS9, CS9FX600) - The lockout box (a flatter rectangular white box) with a toggle dome button and LED light. When the light is on, the HILO on the hand pendant will not function.	
		Lockout LED on the Attendant Control Pad (ACP) is ON.	Toggle-off the individual function lockout (LED should be OFF)
	Loose wire connections.	Check cable connections visually.	Connect any loose cable couplings and/or power supplies.
	Faulty actuator.	Disconnect power supply, swap cable from unresponsive actuator with a functional actuator. Reconnect power and test functions. Faulty actuator will not work regardless of the connection port.	Contact Invacare Continuing Care Service Department 1-800-668-2337.

10 TROUBLESHOOTING

EFFECT	POSSIBLE CAUSE	VERIFICATION	CORRECTIVE ACTION
Actuator not working.	Faulty hand control pendant.	Pendant cable is connected, power is on, lock-out is off and hand control pendant does not function. Disconnect power supply then replace hand pendant with functioning unit (from another bed, if available). Reconnect power and test.	Contact Invacare Continuing Care Service Department 1-800-668-2337.
Bed ends do not fit properly.	Bent brackets.	Visually ensure the brackets are parallel to the frame.	Carefully straighten minor deformations. Call Service Department to replace significantly bent brackets, 1-800-668-2337.

For Customer Service, call 800-668-2337

Invacare Continuing Care, Inc.
A subsidiary of Invacare Corporation.

For more information regarding Invacare continuing Care,
Inc. (ICCI) products, parts, and services, please visit
www.invacare-cc.com or call 800-668-2337

Part No 1153410 Rev L - 3/12



**Manufacturing
Location:**

994 Hargrieve Road
London, Ontario
Canada
N6E1P5

**Invacare Continuing
Care, Inc.**

USA and Canada:
One Invacare Way
Elyria, Ohio USA
44036-2125

Invacare Australia Pty. Ltd.

1 Lenton Place
North Rocks NSW 2151
Sydney, Australia
011-61-2-8839-5333

www.invacare-cc.com



Yes, you can.