

Kangaroo™

Epump Enteral Feed and Flush Pump with Pole Clamp, Programmable

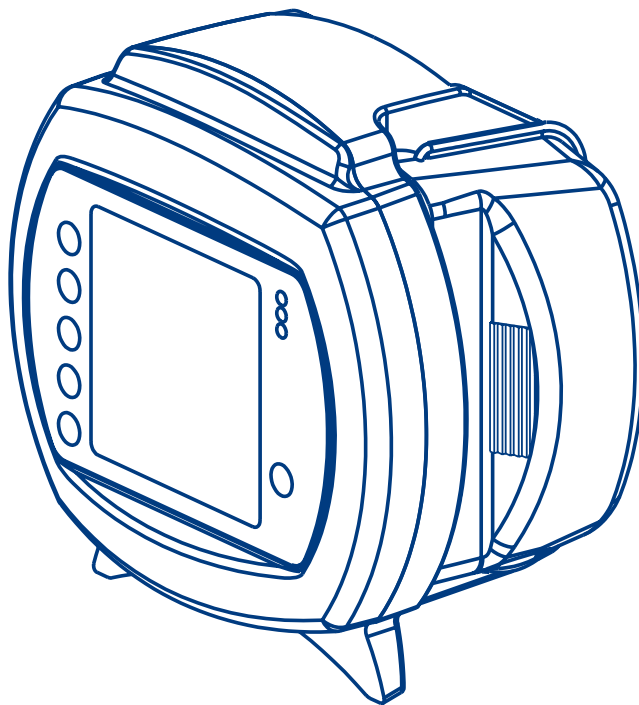

[Click here to view detailed product descriptions and prices.](#)

Call 800-397-5899 to order today!

Thank you for purchasing the Kangaroo™ Epump Enteral Feed and Flush Pump with Pole Clamp.
With proper care, this device will provide you with years of precision service.

Table of Contents

	Page
Section I — General Information	1
Section II — Safety and Warnings	3
Section III — Icon Identification	4
Section IV — Initial Setup	
Attaching the A/C Power Adapter	5
Battery Setup	6
Attaching Pole Clamp	6
Section V — Instructions for Use	
Quick Start	7
General Startup	
Placement/Mounting	8
A/C Power Operation	8
Battery Power Operation	8
Power On/Off	8
Language Selection, First Power Up	8
Keep or Clear Prior Pump Settings	8
Loading Pump Sets	9
Prime Pump	10
Auto Priming	10
Hold-To-Prime	10
Re-priming after Bag Empty	11
Selecting Feed Mode	11
Selecting EZMODE	12

Table of Contents

Selecting Continuous or Intermittent Mode	12
Continuous Mode (Adjust Feed)	
Continuous Mode Feeding	13
Continuous Mode Flushing	13
Intermittent Mode (Adjust Bolus)	
Intermittent Mode Feeding	14
Intermittent Mode Feeding - Bolus Max.	14
Intermittent Mode Flushing	15
Run	15
Keep Tube Open (KTO)	16
Lock Screen Feature	16
Hold	17
Flush Now	18
More Options	18
Buzzer Alarm Volume	18
History	18
Language Selection	18
Continuous/Intermittent Mode	18
BioTech Menu	19
Accessing the BioTech Screen	19
BioTech Screen Data	19
BioTech Options	19
Lock Settings Feature (Program Locked)	19
EZMode	19
Communication	19

Section VI — Performance Evaluation

System Performance Tests	20
Certifying the Accuracy of Pump Flow Rate	20

Section VII — Cleaning

Section VIII — Battery Replacement

Table of Contents

Section IX — Error/Warning/Informational Screens and Troubleshooting

System Error	23
Hold Error	25
Rotor Error	25
Feed Error	25
Flush Error	25
Flow Error	25
Pump Set Dislodged Error.....	26
Battery Low	26
Feeding Complete	26
Pump Set Use >24 Hours Warning	26
LED Array	26

Section X — Specifications and Symbols

Specifications.....	27
Symbols on Pump and Accessories	29

Section XI — Customer Service 30

Section XII — Maintenance

Side Door Enclosing Pump Set Loading Area	30
Battery Pack	31
Battery Door	31
A/C Power Adapter	31
Pole Clamp	31

Section XIII — Service Part Numbers 31

Section XIV — Warranty 32

Section XV — Electromagnetic Conformity Declaration 33

This product contains software solely owned by Covidien. Covidien grants the user a non-exclusive, limited license to use the software according to the operating instructions. A copy of the license can be obtained from Covidien.

Section I – General Information

The Kangaroo Epump Enteral Feed and Flush Pump with Pole Clamp is a simple-to-use, precision enteral feeding pump. It is easily programmed to provide patients with either continuous or intermittent feeding, and can provide automatic flushing capability when used with Kangaroo™ Epump Feed & Flush Sets.

User Interface:

- Intuitive user interface
- Large, backlit LCD display
- Step-by-step prompts to guide programming and operation
- “Stoplight” LED array visually indicates pump status in a bright or darkened room

Ergonomics:

- Quiet operation
- Compact, aesthetic design
- Tabletop usage or IV pole mounting
- Simple loading of Pump Sets
- Transparent side door to protect Pump Set
- Integrated handle for easy transport

Features:

- MISTIC (Magnetic Intelligent Set Type Identification Connector) Feed-Only vs. Feed & Flush Set identification system to ensure match between the pump’s user interface and Pump Set type
- Automatic Anti-Free-Flow (AFF) System
- Audible alarm to indicate errors or Pump Set loading conditions
- Attitude-independent design eliminates need for drip chamber on pump set
- Sensor technology detects both upstream and downstream flow conditions
- Continuous feed, intermittent feed, and flush capability
- Auto-prime feature reduces the need for time-consuming manual priming
- Hold feature with restart and Keep Tube Open (KTO) feature
- Stores previous 72 hours of feeding and flushing history

Service:

- Serial I/O port for data retrieval
- Uses replaceable, rechargeable NiMH Battery Pack for 15 hours of backup power
- Removable A/C Power Adapter

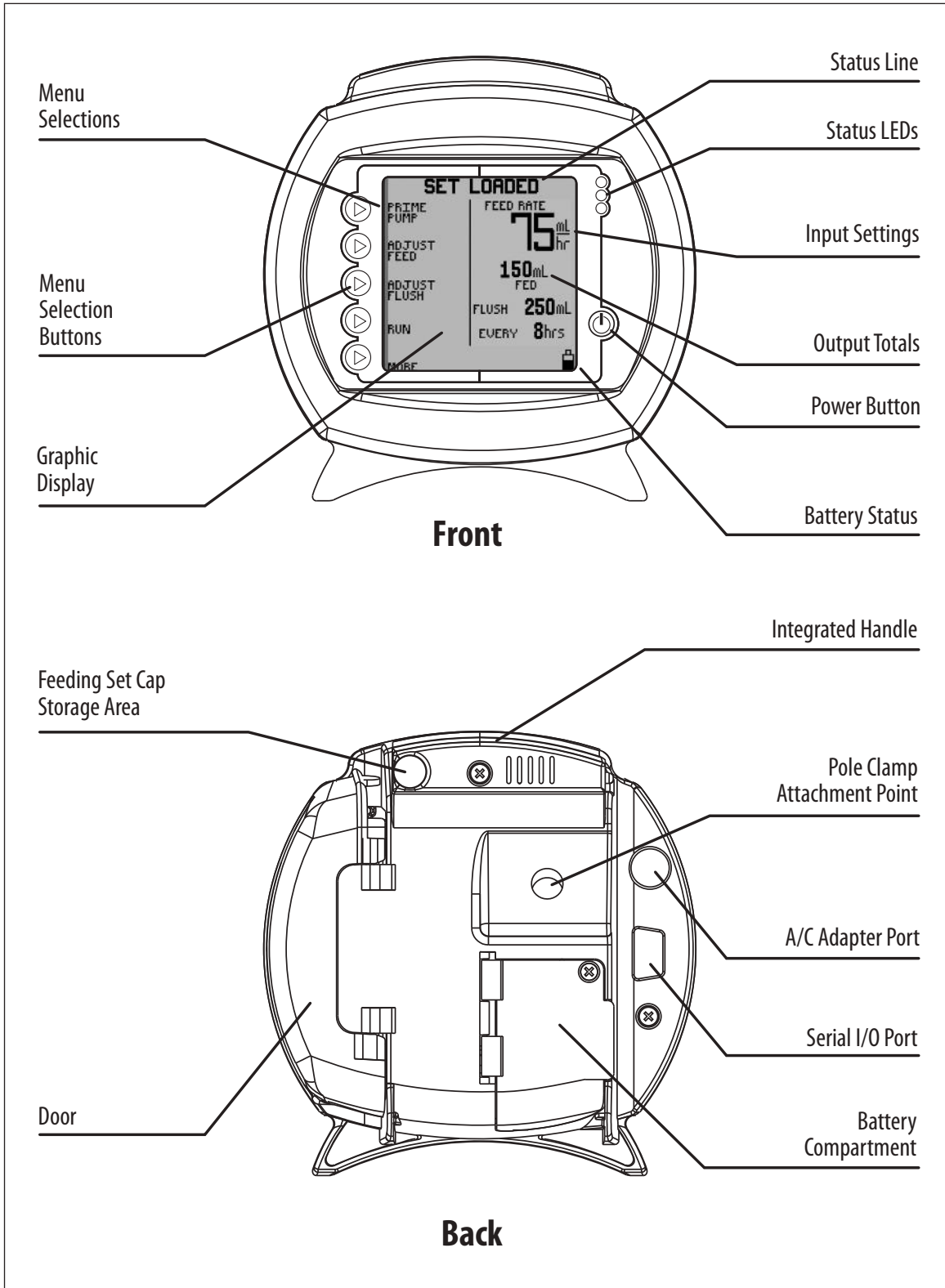

Figure 1A. Kangaroo™ Epump features, front and rear views.

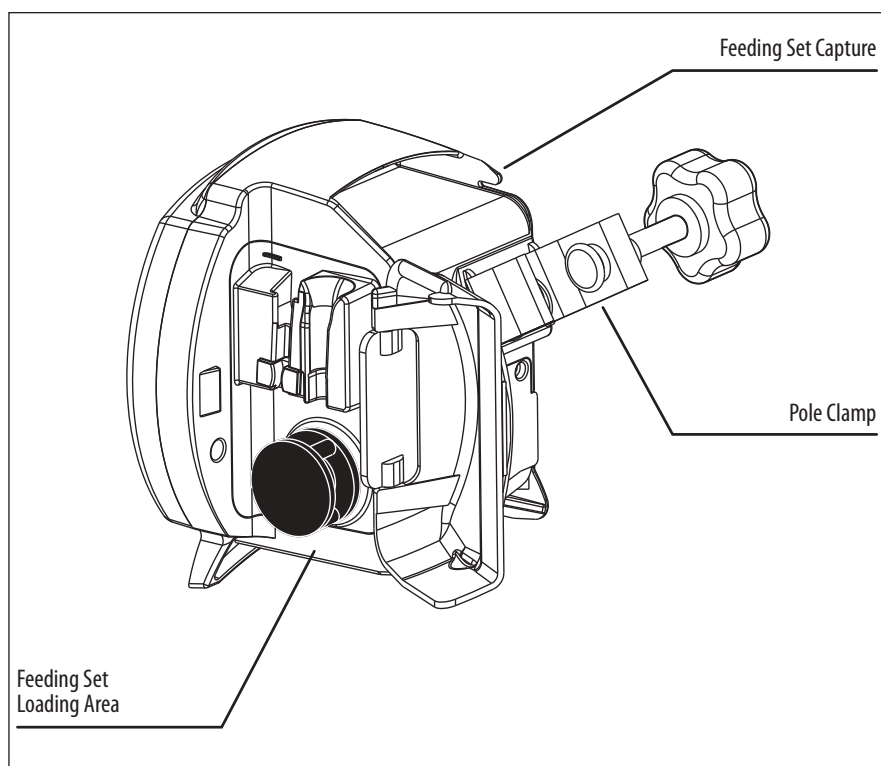

Figure 1B. Kangaroo™ Epump Pump Set loading area.

Section II — Safety and Warnings

Caution: U.S. federal law restricts the sale of this device to physicians or to their direct representatives.

1. Read this booklet thoroughly before using the Kangaroo Epump Enteral Feed and Flush Pump.
2. Do not use this device near flammable anesthetics.
3. Disconnect power supply before cleaning or servicing.
4. Use only Kangaroo™ Epump Enteral Feed and Flush Pump A/C Power Adapter with pump. See Section XIII - Service Part Numbers for replacement of Power Adapter. **Use of an alternate consumer style A/C power adapter may cause damage to the charging circuit and battery of the Kangaroo™ Epump feeding pump.**
5. Use only Kangaroo Epump Enteral Feed and Flush Pump Pump Sets with this device. Pump is not compatible with other Pump Sets.
6. For performance tests, see Section VI - Performance Tests. For other integrity checks, consult with a qualified Biomedical technician or contact the manufacturer (Section XI - Customer Service).
7. For service or for technical information, please contact Customer Service (Section XI).
8. Do not open the main housing, as there are no user-serviceable parts inside. Opening may affect function of device and voids the warranty. To replace battery, see Section VIII.
9. Dispose of old battery-powered electronic equipment in a manner consistent with institutional policy for expired equipment disposal.
10. Cleaning frequency and practices must be consistent with institutional policy for cleaning of non-sterile devices. See Section VII - Cleaning, for instructions on cleaning the Kangaroo Epump Enteral Feed and Flush Pump.

11. See icon descriptions in Section III - Icon Identification and Section X - Specifications and Symbols for additional safety information.
12. This device is designed to minimize the effects of uncontrolled electromagnetic interference and other types of interference from external sources. Avoid use of other equipment that may cause erratic operation or degradation in the performance of this device.
13. **Warning:** The serial I/O port (see Figure 1A) is intended only for use with the approved Communication Cable (Part Number 382499).
Any other equipment that can be connected to the DB9 Serial I/O port may lead to a reduced level of safety of the pump.
 - The Covidien approved Communication Cable (Part Number 382499) is specifically approved as complying with the safety requirements for accessories used with the pump, whereas the safety approval of the accessory has been performed in accordance to the appropriate IEC 60601-1 and/or IEC 60601-1-1 harmonized standard.
14. **Caution:** This enteral feeding pump should only be used for patients who can tolerate the flow rates and accuracy levels delivered by the pump. Premature infants may require higher accuracy rates than specified for this enteral feeding pump.
15. Do not attempt to rotate the valve stem inside the feeding set valve assembly. Rotation of the valve stem can only be done by the pump while the valve assembly is properly loaded into the pump.
16. Should feeding sets require rinsing, it is recommended that the feeding sets be rinsed while they are loaded in the pump.
17. Used feeding sets should be disposed of in accordance with current hospital procedure or local disposal guidelines.
18. **Caution:** Ensure buzzer hole is unobstructed during normal operation so as to allow clear recognition of alarm.
19. **Caution:** The battery cells used in this device may present a fire or chemical hazard if mistreated. Do not disassemble, heat above 100°C (212°F), or incinerate.

Section III – Icon Identification

Run Mode

Vertically-moving droplet in *RUNNING* screen indicates Run mode.



Battery Symbols

- Full charge
- 2/3 or less charge
- 1/3 or less charge
- Very low battery (15 minutes max.)

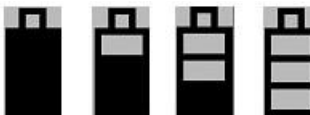

Auto Priming Indicator

When auto priming, the bar will progress to show auto prime feature is active.



Volume Setting

Indicates alarm volume setting.



Error Indicator

Pump operations are stopped until the error is resolved.



Information Indicator

This indicates information only, and does not require any immediate action.



EZMODE Indicator

Indicates that EZMODE feature is turned on.



Communication Indicator

Indicates that communication feature is turned on.



Volume to be Delivered Indicator

Indicates that VTBD feature is turned on.



Keep Tube Open

Indicates that Keep Tube Open feature is turned on.



Section IV — Initial Setup

Attaching the A/C Power Adapter

Plug the A/C Power Adapter (Part Number 382491) into the A/C Adapter Port on the back of the pump. See Figure 1A to locate port on pump. Make note of the location of the pins and tab on the plug to properly orient the plug.

The connector, which attaches to the back of the pump, has a spring-loaded locking sleeve that locks into the pump, thus helping to prevent the connector from being accidentally unplugged from the pump. To remove the connector, grasp the outer sliding sleeve member and pull. Do not detach the connector by pulling on the cord only.

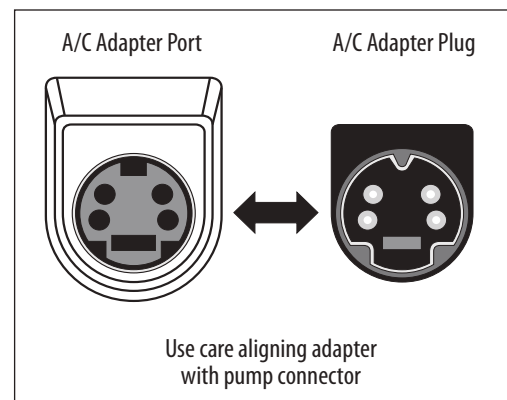

Figure 2. Alignment of A/C Adapter plug with pump's adapter port.

Battery Setup

The battery pack is fully charged before shipping, and is left unconnected to optimally preserve battery life.

Warning: The battery should be connected before using the pump.

It is also recommended that the battery charge be “topped off” before battery-only operation is utilized. The battery pack will charge continuously whenever the pump is plugged into a wall outlet, including during normal use of the pump with A/C power. Eight hours of charging is required to fully recharge the battery pack.

A new battery pack will provide approximately 15 hours of service before needing to be recharged.

Attaching Pole Clamp

The Kangaroo Epump Enteral Feed and Flush Pump can be attached to a vertical pole using the Pole Clamp, included with the pump. The pole clamp provides the ability to retain the power cord to prevent accidental cord removal or cord loss. Simply place the A/C Adapter Power cord into the U-shaped groove located on the back of the pole clamp as shown in Figure 3 and attach the pole clamp to the Kangaroo Epump Enteral Feed and Flush Pump. Be sure not to pinch the cord of the A/C power adapter or damage the cord insulation when installing.

To attach the Pole Clamp to the Kangaroo Epump Enteral Feed and Flush Pump, align the hole on the Pole Clamp with the mounting hole on the back of the pump. Use a 3/8" - 16 bolt to fasten together, as shown in Figure 3.

If cord restraint is preferred but use of the pole clamp is not desired, a cord restraint clip is provided with the Kangaroo Epump Enteral Feed and Flush Pump. Using the pole clamp mounting bolt, follow the pole clamp assembly instruction to attach the cord clip (Refer to Fig. 3).

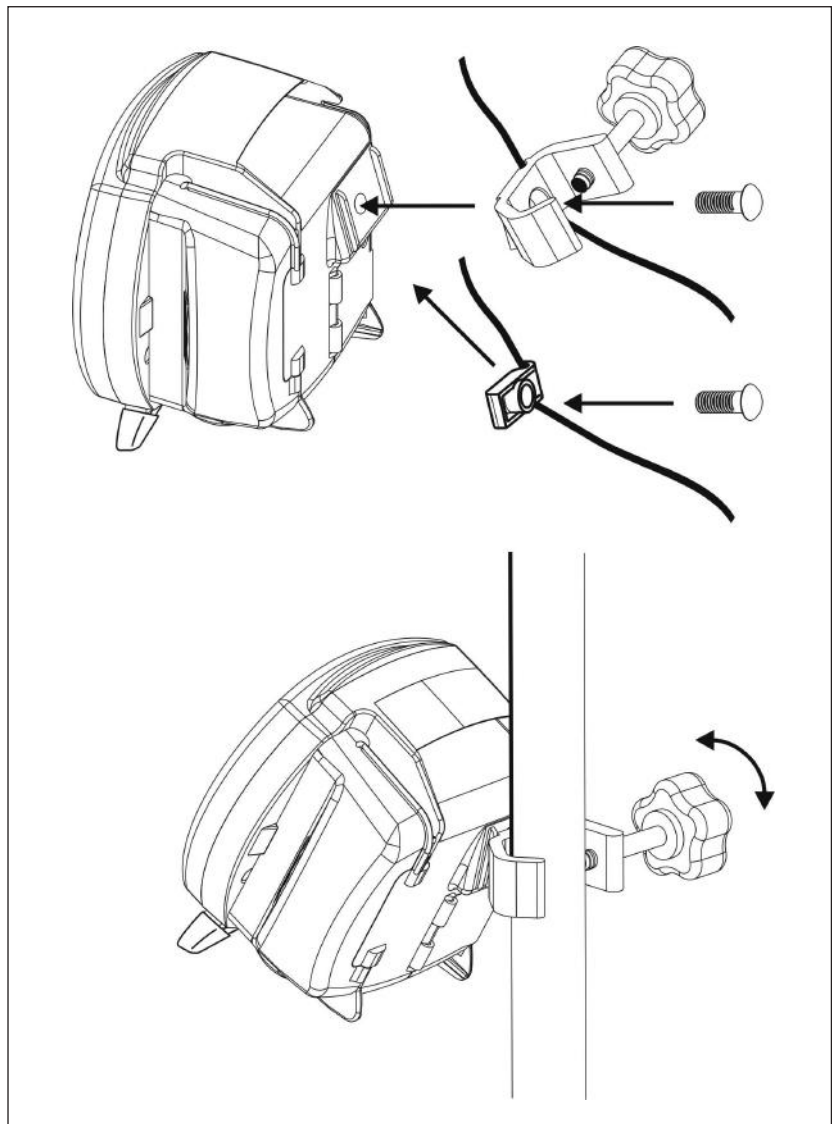

Figure 3. Attaching and using the Pole Clamp or Cord Clip.

Section V — Instructions For Use

Quick Start

1. Press **POWER** on lower, right-hand corner of control panel.
2. Open blue door enclosing Pump Set loading area.
3. To load Pump Set, refer to Figure 4:
 - Grasp finger tab on valve and insert into left pocket (1).
 - Grasp black ring retainer and gently stretch tubing around rotor (2). Pull up on retainer and insert into right pocket (3).
 - Press down on finger tab to ensure that valve is fully seated. Finger tab should align with locating rib.
 - Close blue door.

(Note: display status line should read **SET LOADED**).
4. To automatically prime the pump, press **PRIME PUMP** and **AUTO PRIME**. For Kangaroo Epump Feed & Flush sets, auto priming will prime both lines.
5. To directly control pump priming, press **PRIME PUMP** and then press and hold the **HOLD TO PRIME** button(s). If a Feed & Flush Set is used, remember to first press **HOLD TO PRIME FLUSH** until the flushing fluid has reached the valve, and then press **HOLD TO PRIME FEED** until the feeding fluid has reached past the valve and down to the distal end connector.
6. Use buttons on left side of LCD to set the feeding parameters. Set flushing parameters if a Feed & Flush Set is loaded. The continuous or intermittent feed mode selection is made under the **MORE** options menu.
7. Press **RUN** when ready to start. The screen will display **RUNNING**.
8. To stop, press **HOLD** or press and hold the **POWER** button.

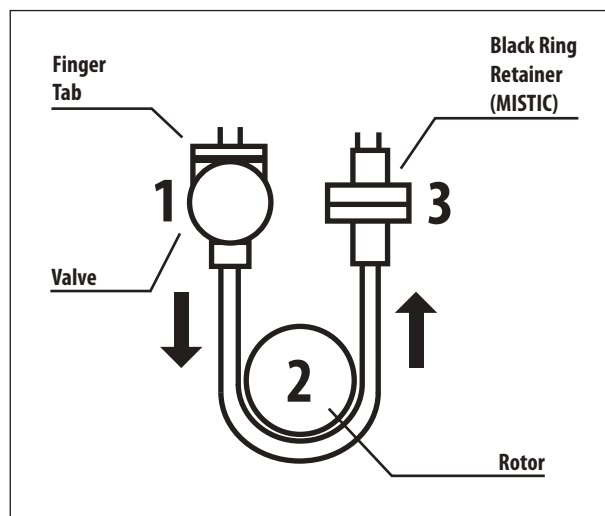

Figure 4. Installation of Pump Set.

General Startup

Placement/Mounting

There are two recommended placement methods for the Kangaroo Epump Enteral Feed and Flush Pump.

- Attached to a vertical IV pole via the Pole Clamp peripheral device, included with the pump.
- Placed feet down on any horizontal surface.

A/C Power Operation

Plug the Kangaroo Epump Enteral Feed and Flush Pump into an A/C power outlet for normal operation. When the pump is not plugged in, or if A/C power is interrupted, a built-in rechargeable battery will run the pump.

Battery Power Operation

If A/C power is not available to the pump, or if A/C power is interrupted, the pump will automatically operate on backup battery power. The built-in battery recharges any time the pump is plugged into an outlet.

A fully-charged, new battery will supply 15 hours of backup power at 125 mL/hr before requiring recharging. Contact Customer Service, Section XI, to replace the Battery Pack if battery life degrades.

Power On/Off

To power up the pump, press the **POWER** button on the lower right of the front panel. To power down the pump, press and hold the **POWER** button. A countdown will begin on the display; when the countdown reaches 0, immediately release the **POWER** button. **Note:** The display backlight and Status LED array will remain on for a short period after releasing the **POWER** button while the pump completes its internal power down process and will then extinguish.

Language Selection, First Power Up

Immediately after powering up the pump for the first time, the language option screen will appear. Select the language using the (**↑**) or (**↓**) buttons. When the language is selected, push the fifth button (**→**) to enter the language selection. After the language is selected the first time the pump is powered up, the language selection screen will not appear during future power up operations. Should the language need to be changed after the initial power up, it can be changed through the **"MORE OPTIONS"** menu (see Figure 10A).

Keep or Clear Prior Pump Settings

Immediately after powering up the pump, if the prior feed or flush settings were not cleared and the settings are not locked in the BioTech Screen, the pump will give the following two options:

KEEP SETTINGS - Select this option to start with the same settings that were most recently programmed into the pump. Any of the previously-programmed settings can be modified, if needed. The feed volume totals, **"mL FED"** (Continuous Feed Mode) or **"BOLUSES FED"** (Intermittent Feed Mode) and **"mL FLUSH"** are also maintained.

CLEAR SETTINGS - Select this option to reset all input feeding settings and the output feed totals to zero. It will then be necessary to program all settings before running the pump. The BioTech options settings will not change.

The status line of the pump will then show **LOAD A SET** (Figure 5), or, if the Pump Set is already loaded, it will show **SET LOADED** (Figure 7).

Note: The output feed totals (“mL FED,” “BOLUSES FED,” “mL FLUSH”) can be cleared at any time, and without clearing the input settings, by doing the following:

- Start the pump **RUNNING**
- Press ▶ **HOLD**
- Press ▶ **CLEAR VOLUME**

Loading Pump Sets

The Kangaroo Epump Enteral Feed and Flush Pump will indicate **LOAD A SET** in the screen’s status line if a Pump Set is not installed. A blinking icon of a Pump Set will also appear in the upper left corner of the screen. Figure 5A shows the screen for continuous feeding mode and Figure 5B shows the screen for intermittent feeding mode (intermittent feeding mode not available in EZMODE).

To load a Pump Set, follow the steps below:

1. Open the blue transparent door that encloses the rotor and Pump Set loading area.
2. Load the Pump Set by holding the finger tab on the valve, and inserting the valve down into the slot on the left. (Figure 6A)
3. Grasp the MISTIC retainer end (black ring retainer) and wrap the tubing counterclockwise around the rotor. **Avoid overstretching the silicone tubing.** (Figure 6B)
4. Carefully pull the MISTIC retainer end upwards to position it over the slot on the right, and then lower the retainer into the slot. (Figure 6B)
5. Press down on the valve’s finger tab to ensure proper seating.
6. Close blue transparent door.
7. **The bottom of the feed bad should be 18 inches from the top of the pump.**

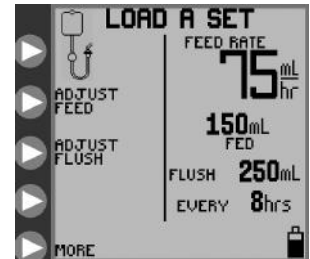

Figure 5A. **LOAD A SET** opening menu screen for Continuous Feeding mode (EZMODE not activated).

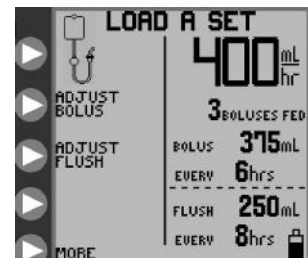

Figure 5B. **LOAD A SET** opening menu screen for Intermittent Feeding mode (EZMODE not activated).

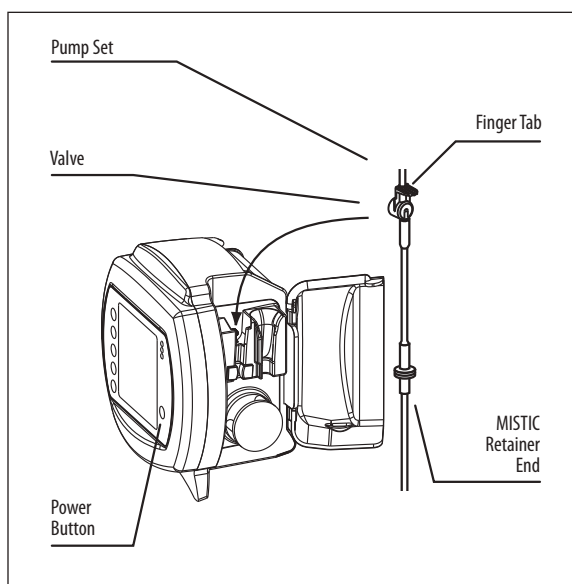

Figure 6A.

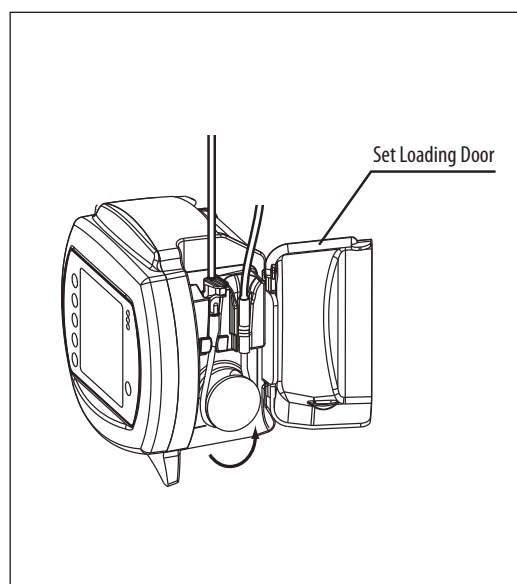

Figure 6B.

The display should read **SET LOADED** and will show one of the following opening menus, depending on the type of Pump Set detected, and whether continuous or intermittent feeding mode has been selected.

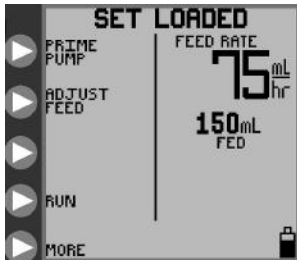

Figure 7A. Opening menu for Continuous Feed mode with a Feed-Only set.

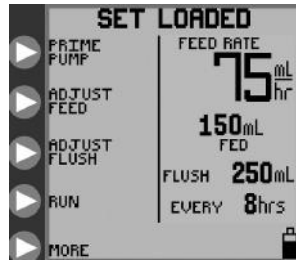

Figure 7B. Opening menu for Continuous Feed mode with a Feed & Flush set.

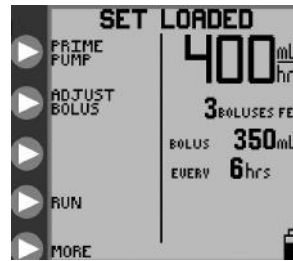

Figure 7C. Opening menu for Intermittent Feed mode with a Feed-Only set.

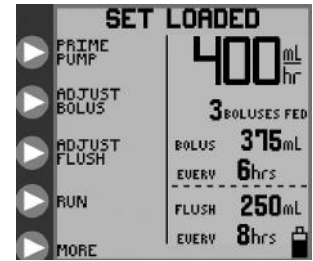

Figure 7D. Opening menu for Intermittent Feed mode with a Feed & Flush set.

Prime Pump

The Kangaroo Epump Enteral Feed and Flush Pump may be primed automatically with a single button push, including the flushing line if a Feed & Flush Set is loaded. The pump can also be primed in a more interactive method using the hold-to-prime feature.

After a Pump Set has been loaded and the status line shows **SET LOADED**, press ► **PRIME PUMP** in the opening menu (Figures 7A-7D) to get one of the **PRIME PUMP** menus shown in Figures 8A-8B.

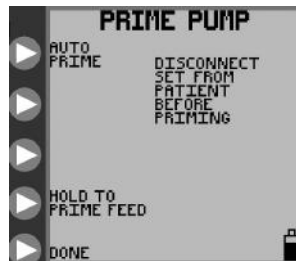

Figure 8A. PRIME PUMP menu for Feed-Only set.



Figure 8B. PRIME PUMP menu for Feed & Flush set.

Auto Priming

The **AUTO PRIME** option will be available if the pump senses that the currently installed Pump Set was not previously primed, and that there is no fluid in the line near the rotor. If auto-priming is desired, press and release ► **AUTO PRIME** to automatically prime the line(s). For Feed & Flush Pump Sets, the auto prime feature will automatically prime both lines, starting with the flush line.

Press ► **STOP** to cancel **AUTO PRIME**.

When auto-priming is completed, the status line will show **AUTO PRIME COMPLETE** and will no longer show the **AUTO PRIME** option. Be sure that the line(s) are fully primed. If not, use the hold-to-prime option(s) to complete the priming, as described below.

Hold-to-Prime

The hold-to-prime options allow for precise interactive control of the priming process.

Feed-Only Pump Sets

For Feed-Only Pump Sets, the screen will appear as in Figure 8A. Press and hold ► **HOLD TO PRIME FEED** until the feed line has been primed down to the stepped end connector at the end of the Pump Set.

Feed & Flush Pump Sets

For Feed & Flush Pump Sets, the display will appear as in Figure 8B. First press and hold ► **HOLD TO PRIME FLUSH** to prime the flushing line, and then press and hold ► **HOLD TO PRIME FEED** to prime the feed line down to the stepped end connector at the end of the Pump Set.

If a Feed & Flush Pump Set is used, remember to first press ► **HOLD TO PRIME FLUSH** until the flushing fluid has reached the valve, and then press ► **HOLD TO PRIME FEED** until the feeding fluid has reached past the valve and down to the stepped end connector. If the feeding line is primed first, subsequent priming of the flushing line will force the air between the flush solution bag and valve into the main line, which already has been primed with enteral formula.

Re-priming after Bag Empty

A Pump Set bag that has been emptied will trigger the **FEED ERROR** screen. In this condition the Pump Set bag can be refilled to continue the feeding, but only after the Pump Set has been re-primed.

To re-prime the Pump Set, do the following:

- Disconnect the feeding line from the patient
- Refill the bag
- Press ► **CONTINUE** to begin the pump **RUNNING**
- Press ► **HOLD**
- Press ► **ADJUST SETTINGS**
- Press ► **PRIME PUMP**
- Press ► **HOLD TO PRIME** to prime the line(s)

Pump Sets should not be reused after 24 hours of initial usage.

Selecting Feed Mode

EZMODE Option

The **EZMODE** option is a limited, **CONTINUOUS MODE** only setting of Epump. It feeds non-stop (no VTBD option) at a rate 0-400mL/hr as defined by the user until manually stopped. It has no **BOLUS, FLUSHING, RUN MODE SCREEN LOCK, or AUTORESUME** capability and displays no **HISTORY** information.

Turning on **EZMODE** will automatically force the unit out of the **INTERMITTENT (BOLUS FEED)** mode if set. Although the Continuous Mode feed VTBD will be set to 0 while **EZMODE** is enabled, the previous value of the **Feed VTBD** will be stored in flash memory and recalled when “**EZMODE**” is deselected. The user can change the Feed Rate by normal means. All other user settings, including those not compatible with the **EZMODE (BOLUS VTBD, NUMBER OF BOLUSES, SUPER BOLUS, etc)**, that were set before the pump was put into the **EZMODE** will be ignored and invisible while in **EZMODE** but remain stored in the flash memory for when **EZMODE** is deselected. **EZMode** essentially has no effect on **CLEAR SETTINGS**; pressing **CLEAR SETTINGS** while **EZMODE** is enabled will clear all Feed and Flush settings and totalizers as normal, not just those that apply to **EZMODE**. Selecting the **CLEAR SETTINGS** option on power up will not clear **Biotech Options** such as **EZMODE** or **LOCK SETTINGS**.

If the user selects the **ADJUST FEED** option from either the **LOAD A SET** or **SET LOADED** screens, control will pass directly to and from the Enter Feed Rate screen and bypass the **ADJUST FEED** screen since without the ability to adjust VTBD in **EZMode**, the Adjust Feed screen is redundant.

Selecting EZMODE

EZMODE may be selected through the **Biotech Options** button which may be accessed on the Biotech screen (see page 19). The **EZMODE** setting will be stored in the flash memory and saved when the unit is shut off.

Note: If the user inserts a Feed/Flush set while the **EZMODE** is enabled, **EZMODE** will be cancelled and the unit will immediately revert back to the normal mode. If **EZMODE** is desired, the user must then re-enable **EZMODE** through the **Biotech Options** screen.

When enabled and not in **CERTIFICATION MODE**, a small **EZ** icon will be visible on the bottom of the screen near the battery icon. However, it will not appear in the **POWER DOWN, SYSTEM ERROR, or LOW BATTERY SCREENS**.

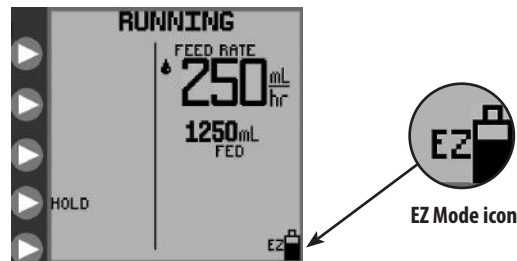

Figure 9.

Selecting Continuous or Intermittent Feed Mode

The Kangaroo Epump Enteral Feed and Flush Pump can be programmed to feed continuously or intermittently.

The continuous feeding mode will deliver the enteral nutrition at a steady rate, either until the programmed volume has been delivered or until the supply has been exhausted. The Intermittent feeding mode delivers boluses of enteral nutrition at programmed time intervals. The bolus volume and feed rate are also programmed.

To select continuous feed mode or intermittent feed mode, press ► **MORE** on the opening menu, shown in Figures 5A-5B or Figures 7A-7D, to access the **MORE OPTIONS** menu, Figure 10A.

The **MORE** option is available either before a Pump Set has been loaded (Figures 5A-5B) or after the Pump Set is loaded (Figures 7A-7D). See subsection "More Options" for information on the other options in the **MORE OPTIONS** menu.

Select ► **CONTINUOUS/INTERMITTENT** under the **MORE OPTIONS** menu, Figure 10A. Then press ► **CONTINUOUS MODE** or ► **INTERMITTENT MODE** from the **SELECT MODE** menu, Figure 10B. Press ► **DONE** to exit.



Figure 10A. **MORE OPTIONS** menu.



Figure 10B. **SELECT MODE** menu for continuous or intermittent mode selection.

Continuous Mode — Adjust Feed

Continuous Mode Feeding

For **CONTINUOUS** feeding mode, the **ADJUST FEED** option is available in the opening menus (Figure 7A for Feed-Only sets or Figure 7B for Feed & Flush sets). Select this option to program the feeding parameters from the **ADJUST FEED** screen, Figure 11A.

Press ► **FEED RATE** in Figure 11A to define the rate of delivery. Press the ► buttons in Figure 11B to program the rate from 1 to 400 in increments of 1 mL/hr. Press ► **ENTER** (top button) to exit the menu.

Press ► **FEED VTBD** in Figure 11A to define the Volume To Be Delivered. Press the ► buttons in Figure 11C to program the volume from 1 to 3000 mL in increments of 1 mL. Press ► **ENTER** (top button) to exit the menu. If the **FEED VTBD** is set to zero, the pump will run until the supply is exhausted.

Note: When a **FEED VTBD** is set, the remaining volume to be delivered (remaining VTBD) will be displayed next to the  icon on the lower right-hand portion of the screen (Figure 11A). If the **FEED VTBD** is reprogrammed during a feeding, from **HOLDING** mode, the pump will restart the feeding and deliver the entire volume of the new VTBD setting.

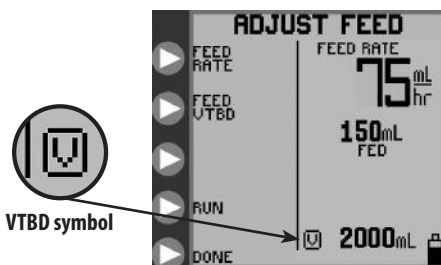

Figure 11A. **ADJUST FEED** menu.

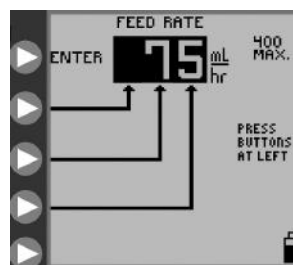

Figure 11B. Setting the Feed Rate.

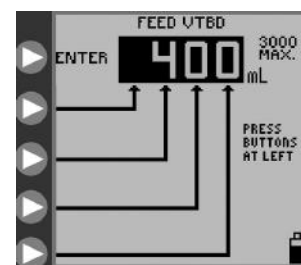

Figure 11C. Setting the Feed Volume to be Delivered.

Continuous Mode Flushing *(Not Available in EZMODE)*

For **CONTINUOUS** feeding mode with a Feed & Flush Set loaded, the opening menu will appear as shown in Figure 7B.

Press ► **ADJUST FLUSH** in Figure 7B to program the flushing parameters from the **ADJUST FLUSH** screen, shown in Figure 12A.

Press ► **FLUSH VOLUME** in Figure 12A to define the volume per flush occurrence. Press the ► buttons in Figure 12B to program the flush volume from 10 to 500 in increments of 1 mL. Press ► **ENTER** (top button) to exit the menu.

Press ► **FLUSH INTERVAL** in Figure 12A to define the time interval between starts of flushing. Press the ► buttons in Figure 12C to program the time interval from 1 to 24 hours in increments of 1 hour. Press ► **ENTER** (top button) to exit the menu.

The pump will automatically limit flushing settings which exceed pump capabilities to deliver.

Caution: The Kangaroo Epump Enteral Feed and Flush Pump flushes at a rate of 1960 mL/hr (32.7 mL/minute). Use care when programming the flush volume so that it matches the patient's need.

Note: The pump will automatically flush an additional 25 mL of water after completing the programmed delivery of formula, as long as at least one flush had occurred during formula delivery.

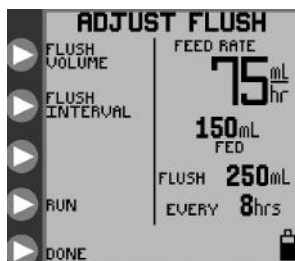

Figure 12A. **ADJUST FLUSH** menu, continuous mode.

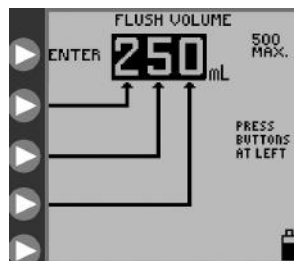

Figure 12B. Setting the Flush Volume.

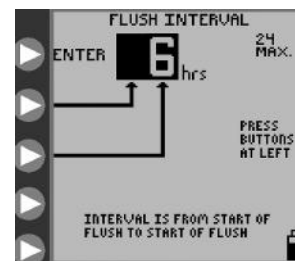

Figure 12C. Setting the Flush Time Interval.

Intermittent Mode — Adjust Bolus *(Not Available in EZMODE)*

Intermittent Mode Feeding

For **INTERMITTENT** feeding mode, the **ADJUST BOLUS** option is available in the opening menus (Figure 7C for a Feed-Only set or Figure 7D for a Feed & Flush set). Select this option to program the feeding parameters from the **ADJUST BOLUS** screen, Figure 13A.

Press ► **BOLUS RATE** in Figure 13A to define the rate of delivery.

Press the ► buttons in Figure 13B to program the delivery rate from 1 to 400 in increments of 1 mL/hr. Press ► **ENTER** (top button) to exit the menu.

Press ► **NUMBER OF BOLUSES** in Figure 13A to define the total number of boluses to be delivered.

Press the ► buttons in Figure 13C to program the number of boluses, up to a maximum of 99.

Press ► **ENTER** (top button) to exit the menu. The number of boluses can be set as zero, in which case the pump will run until the supply is exhausted.

Press ► **VOLUME PER BOLUS** in Figure 13A to define the Volume to be delivered in each bolus.

Press the ► buttons in Figure 13D to program the volume per bolus from 1 to 3000 mL in increments of 1 mL.

Press ► **ENTER** (top button) to exit the menu.

Press ► **BOLUS INTERVAL** in Figure 13A to define the time interval between starts of bolus deliveries.

Press the ► buttons in Figure 13E to program the time interval between starts of bolus deliveries from 1 to 24 hours in increments of 1 hour. Press ► **ENTER** (top button) to exit the menu.

The pump will automatically limit bolus settings which exceed pump delivery capabilities. For example, a bolus delivery volume of 200 mL cannot be made once per hour if a rate of 150 mL/hr is already programmed. In this case, the maximum volume allowed would be 150 mL.

Note: If the **NUMBER OF BOLUSES** is reprogrammed during a feeding (from **HOLD** mode), the pump will restart the bolus feeding and will deliver all the boluses as defined by the new setting.

Intermittent Mode Feeding – Bolus Max *(Not Available in EZMODE)*

The **BOLUS MAX** option can be used to deliver a bolus at a high rate, similar to gravity feeding.

Press ► **BOLUS MAX** in the **BOLUS RATE** menu, Figure 13B, to program the **BOLUS MAX** mode.

The feeding rate for **BOLUS MAX** is 999 mL/hr.

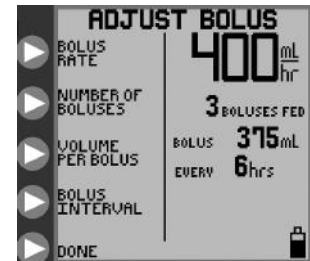

Figure 13A. **ADJUST BOLUS** menu.

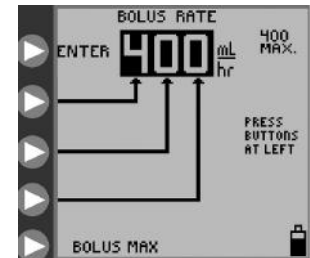

Figure 13B. **Setting the Bolus Rate.**

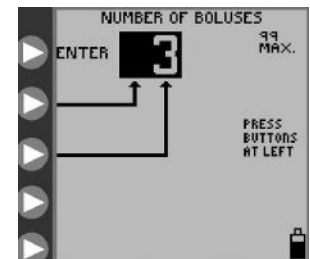

Figure 13C. **Setting the Number of Boluses.**

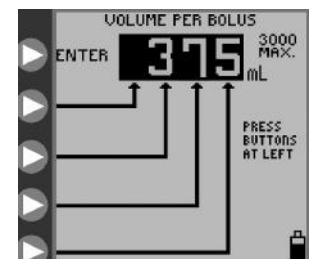

Figure 13D. **Setting the volume per Bolus.**

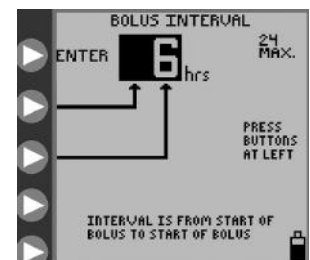

Figure 13E. **Setting the time interval between starts of bolus.**

Intermittent Mode Flushing

For **INTERMITTENT** feeding mode with a Feed & Flush Set, the opening menu, shown in Figure 7D, will show the **ADJUST FLUSH** option. Press ► **ADJUST FLUSH** in Figure 7D to program the flushing parameters from the **ADJUST FLUSH** screen, Figure 14A.

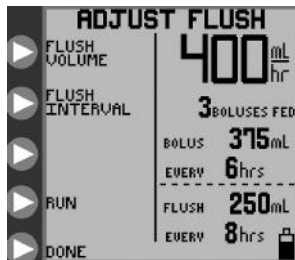

Figure 14A. **ADJUST FLUSH** menu, intermittent mode.

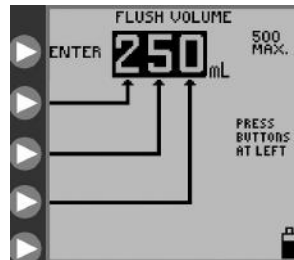

Figure 14B. Setting the Flush Volume.

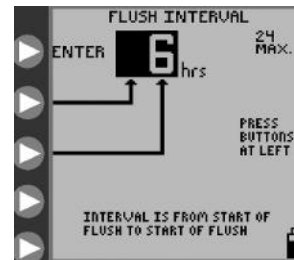

Figure 14C. Setting the Flush Time Interval.

Note: The nature of two intermittent processes, periodic bolus feeding and periodic flushing, is such that occasional conflicts can arise where each process needs to be running at the same time. The flushing process is assigned precedence over the feeding process for Feed & Flush pump sets. “Flushing precedence” means that a flush cycle will run to its end even if a bolus delivery is scheduled to begin. It also means that a flush cycle will interrupt a bolus feeding cycle that is already in progress. The feeding cycle will pick up where it was interrupted after the flushing cycle is complete. It is therefore possible that the net feeding volume is reduced from what may be intended, over a given time period.

Press ► **FLUSH VOLUME** in Figure 14A to define the volume per flush cycle. Press the ► buttons in Figure 14B to program the flush volume from 10 to 500 in increments of 1 mL. Press ► **ENTER** (top button) to exit the menu.

Press ► **FLUSH INTERVAL** in Figure 14A to define the time interval between starts of flushing. Press the ► buttons in Figure 14C to program the time interval from 1 to 24 hours in increments of 1 hour. Press ► **ENTER** to exit the menu.

The pump will automatically limit flushing settings which exceed pump capabilities to deliver.

Caution: The Kangaroo Epump Feed and Flush Pump flushes at a rate of 1960 mL/hr (32.7 mL/minute). Use care when programming the flush volume so that it matches the patient’s need.

Note: The pump will automatically flush an additional 25 mL of water after completing the programmed delivery of formula, as long as at least one flush had occurred during formula delivery.

Run

The Kangaroo Epump Enteral Feed and Flush Pump will only run when a Pump Set is properly loaded and the necessary feeding parameters have been programmed. For a Feed & Flush Set, the flushing parameters do not have to be set for the pump to begin operating. If flushing parameters are set as zeros, there will be no flushing.

After the pump has been programmed, press ► **RUN** to start operation. Figure 15A shows the **RUNNING** screen for continuous feeding with flushing. The status line will indicate **RUNNING**, and the droplet icon will move vertically on the screen. The green LED indicator will be illuminated to give a quick visual indication of positive status in a darkened room.

The **RUNNING** screen shows the feed rate, amount fed, flushing data if a Feed & Flush Pump Set is used, and the remaining volume to be delivered (remaining VTBD). The remaining VTBD is shown next to the  icon.

The **RUN** option can be selected from the following screens, if the proper parameters are programmed and the Pump Set is loaded:

- **SET LOADED** screens (Figures 7A-7D)
- **ADJUST FEED** screen, continuous mode (Figure 11A)
- **ADJUST FLUSH** screens (Figure 12A, 14A)
- **HOLDING** screens (Figure 18A)

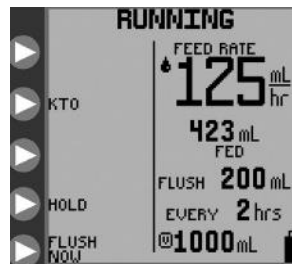

Figure 15A. **RUNNING** mode screen for continuous feed mode.

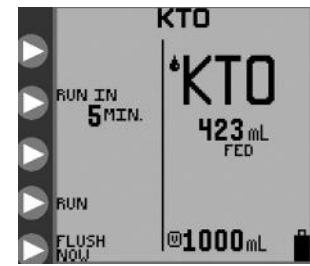

Figure 15B. **KTO**.

Keep Tube Open (KTO) (Not Available in EZMODE)

The Keep Tube Open (**KTO**) function within the Kangaroo Epump Enteral Feed and Flush Pump will help prevent a blockage of the feeding set by moving the feeding solution periodically within the tube. On regular intervals, calculated from the pump's presently programmed feed rate, a small and clinically insignificant portion of feeding solution is moved through the tube. The amount of delivered fluid is monitored, tracked, and calculated into the final feed volume totalizer amounts displayed to the user. The **KTO** feature can be activated via the **RUNNING** screen. To activate the **KTO** feature, press the input button to the left of the **KTO** icon, see Figure 15A, to immediately input a desired time in minutes for which the pump will remain in the "Keep Tube Open" mode before resuming the previously programmed feeding regimen. Each press of the input button will increment the **KTO** time by 5-minute increments, up to 30 minutes, see Figure 15B. After "30" is reached, each additional button press will increment in larger time steps, up to a maximum of 240 minutes. Another button push after 240 will cycle the **KTO** back to 5 minutes. No other input is needed to start the countdown, as the time immediately counts down after the incremental value is reached.



Figure 16. Program Locked screen, which indicates the pump is in **LOCK SETTINGS** mode.

Lock Screen Feature (Not Available in EZMODE)

The Kangaroo Epump Enteral Feed and Flush Pump can be set to **RUN** and then locked out from unauthorized use. While the **LOCK SETTINGS** feature prevents only changes to the input parameters, the **LOCK SCREEN** feature will lock out any button presses, including **RUN** or **HOLD**, except power off.

Use **LOCK SCREEN** when the pump is running and there is a need to prevent tampering such as putting the pump into an unwanted **HOLD**. The **RUNNING** screen will show a padlock to indicate that no changes can be made without unlocking the screen.

To lock the screen, use the following procedure while the pump is in **RUNNING** mode:

- Press and hold the third ▶ button from the top for at least 3 seconds, and then release it.

To unlock the screen, use the same procedure above.

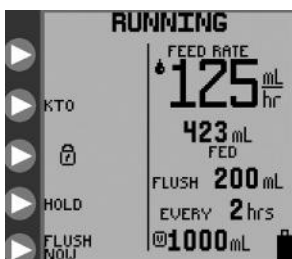

Figure 17. Padlock indicates pump is in **LOCK SCREEN** mode.

Hold

Pump operation can be paused by pressing ► **HOLD** while it is **RUNNING**, such as in Figure 15A. The status line will indicate **HOLDING** and the yellow LED indicator will be lit up to give a quick visual indication of an informational status in a darkened room.

Note: the pump's alarm will sound if it has been left **HOLDING** for 10 minutes without further input.

There are five options available during **HOLDING**. See Figures 18A and 18B.

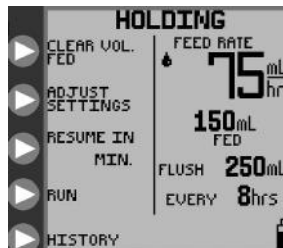

Figure 18A. **HOLDING** mode options, continuous feeding mode.

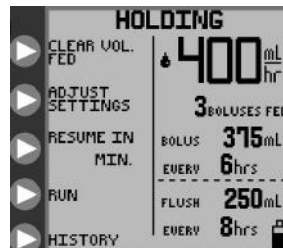

Figure 18B. **HOLDING** mode options, intermittent feeding mode.

Clear Volume Fed

Press ► **CLEAR VOLUME** to re-zero the output feed totals “**mL FED**,” “**BOLUSES FED**,” and “**mL FLUSH**.”

Adjust Settings

Press ► **ADJUST SETTINGS** to return to one of the opening menus shown in Figures 7A-7D, thus allowing any setting to be modified. If the Pump Set has been removed after going into **HOLD**, the opening menu will show **LOAD A SET**, as seen in Figures 5A-5B.

RESUME IN ___ MIN (Not Available in EZMODE)

Press “**RESUME IN ___ MIN**” once to immediately place the Kangaroo Epump into a 30-minute resume running mode. Pressing the **RESUME IN ___ MIN** button again will cycle the “resume in” time back to zero. No other input is needed to start the countdown, as the time immediately counts down after the 30 minute value is reached.

Run Mode

Press ► **RUN** to immediately restart pump operation. This option will not be available if the Pump Set is removed during **HOLD**.

View History (Not Available in EZMODE)

Press ► **HISTORY** to access the **HISTORY** screen. Use this screen to review feeding and flushing history. See subsection “More Options” below for further information.

Flush Now (Not Available in EZMODE)

During the **RUNNING** mode, the pump can be diverted to immediately perform a flush (flush on demand) by pressing ▶ **FLUSH NOW** in the **RUNNING** menu, input a desired flush volume, then press ▶ **ENTER**. See Figure 15A. When ▶ **FLUSH NOW** is pressed, the screen will prompt for the volume to be immediately flushed, and will show the previously programmed flush volume as default but may be adjusted to the users desired volume. The screen will appear as the standard Flush input screen as shown in Figure 12B (or 14B). Setting the **FLUSH NOW** flushing volume is temporary and will not change the main/periodic flushing volume previously programmed. If ▶ **FLUSH NOW** is pressed by accident; the user may either press the cancel button or allow the screen to return to the **RUNNING** screen after 10 seconds, if there is no input for the flush volume.

If stopping a **FLUSH NOW** before the set volume has been delivered is desired, press ▶ **FLUSH NOW** and enter a volume of zero and press ▶ **ENTER**. The **FLUSH NOW** will stop immediately and the pump will return to the **RUNNING** mode.



Figure 19. **MORE OPTIONS** menu.

More Options

Press ▶ **MORE** in one of the opening menus, Figures 5A-5B or Figures 7A-7D, to access the **MORE OPTIONS** screen, Figure 19.

Buzzer Alarm Volume

Press ▶ **BUZZER** in the **MORE OPTIONS** menu to access the **BUZZER** screen and increase or decrease the alarm buzzer volume. The alarm will be audible as the volume setting is changed. This sets the volume level for any warning or error that may occur with the pump. Critical errors of System Error and Pump Set Dislodged will always use the maximum volume setting.

History (Not Available in EZMODE)

Press ▶ **HISTORY** in the **MORE OPTIONS** menu to access the **HISTORY** screen. Press the ▶ buttons in Figure 20 to set the time history of interest. The totals of **FEED mL** and **FLUSH mL** will be shown for the requested history time.

Warning: A maximum of 72 hours of past history can be retrieved, excluding data from the current hour. **NOTE:** The 72-hour history includes time when the pump is powered OFF.

Language Selection

Press ▶ **LANGUAGES** in the **MORE OPTIONS** menu to change the preferred language for the screen interface.

Continuous/Intermittent Mode (Not Available in EZMODE)

Press ▶ **CONTINUOUS/INTERMITTENT** in the **MORE OPTIONS** menu to access the **SELECT MODE** menu, Figure 10B. Use this menu to select between continuous feeding mode and intermittent feeding mode. See subsection "Selecting Continuous or Intermittent Feed Mode" for more information.

Press ▶ **DONE** in the **MORE OPTIONS** menu to exit the menu.

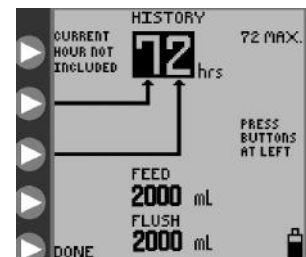

Figure 20. Feed and Flush totals for up to 72 hours of previous history, excluding data from the current hour.

BioTech Menu

The **BioTech** screen will show technical information about the pump, and has a lock feature to lock the Pump Settings against unauthorized changes.

Accessing the BioTech Screen

To get the **BioTech** screen, press the power button to start the pump, and press and hold the top **▶** button while the startup sequence (Kangaroo icon “hops” across the screen) executes. You must be pressing the top **▶** button at the end of the sequence in order to access the BioTech menu. Figure 21 shows the **BioTech** screen.

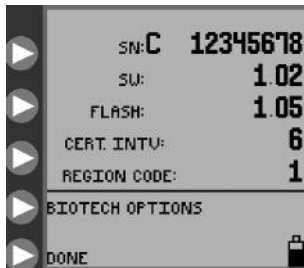

Figure 21. BioTech screen.

BioTech Screen Data

SN is the serial number of the pump.

SW shows the software version number in this pump.

FLASH shows the version number of the flash data installed in this pump.

CERT INTV indicates the number of times the pump has been powered on since certification.

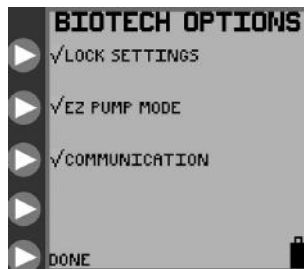

Figure 22. BioTech option screen, with Lock Setting, EZMODE, and Communications features activated.

BioTech Options

Lock Settings Feature — Program Locked

To “lock” the settings against unauthorized changes, press **▶ LOCK SETTINGS** to get the check mark, as shown in Figure 22. The settings can only be changed again by pressing **▶ LOCK SETTINGS** to remove the check mark. If the settings are locked and a change is attempted, the screen will indicate **PROGRAM LOCKED**, and will not allow access to the parameters, Figure 16.

The pump can be **PRIMED** or set to **RUN, HOLD**, etc. when settings are locked.

EZMODE

Press **▶ EZMODE** to activate the **EZMODE** feeding option. A check mark will appear next to the **▶ EZMODE** button to indicate that the feature is active. Pressing the **▶ EZMODE** button again will remove the check mark indicating that the feature is off. If the **EZMODE** feature is turned on, the **EZMODE** icon will appear in the lower right corner of the LCD next to the battery icon (see Figure 9). See page 12 for **EZMODE** details.

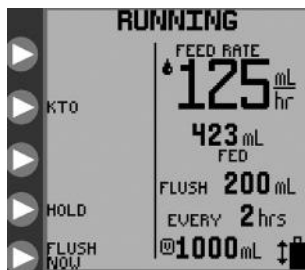
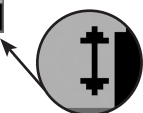

Figure 23.

COMMUNICATION

Press **▶ COMMUNICATION** to activate the communication feature. A check mark will appear next to the **▶ COMMUNICATION** button to indicate that the feature is active. Pressing the **▶ COMMUNICATION** button again will remove the check mark indicating that the feature is off. If the **COMMUNICATION** feature is turned on, the **COMMUNICATION** icon will appear in the lower right corner of the LCD next to the battery icon (see Figure 23).



Communication icon

Turning the **COMMUNICATION** feature on will initiate data transfer of various pump settings, status, errors, etc. through the serial I/O port. If feature is desired, please contact technical support for additional information.

Note: If **EZMODE** and the **COMMUNICATION** feature are both activated the icons for both features will alternate.

Press ▶ **DONE** to exit the **BioTech** menu. To re-enter this menu screen, power down the pump and then power it up again and hold the top ▶ button, as described above.

Section VI – Performance Evaluation

System Performance Tests

A series of tests can be performed to verify pump performance. It is recommended that the evaluation procedure be run at least once per year, or any time the pump is suspected of having improper performance. The test procedure and certificate are included on the User Manual CD as a separate document.

Certifying the Accuracy of Pump Flow Rate

Use the following procedure to check the flow rate accuracy:

- Perform test at room temperature $22^{\circ}\text{C} \pm 2^{\circ}\text{C}$ ($72^{\circ}\text{F} \pm 3^{\circ}\text{F}$) with a new Pump Set.
- Fill a new Feed-Only Pump set bag with water to the 500 mL mark.
- Load the Pump Set.
- **Suspend the Pump Set bag so that the bottom of the bag is 18 inches above the pump.**
- Make sure pump is plugged into A/C power (do not run test with battery power).
- Program a Continuous Mode feed rate (see below for suggested example rates).
- Run the pump for 15 minutes to achieve steady state operation.
- Then begin collecting the water in a calibrated measuring container, such as a large-capacity graduated cylinder, for exactly 30 minutes.

Note: The amount of water collected in 30 minutes will be half of the value programmed for the hourly flow rate, within $\pm 10\%$, or 0.5 mL, whichever is larger.

Rate Set	Amount Expected in 30 Minutes
75 mL/hr	33.7 mL to 41.3 mL
150 mL/hr	67.5 mL to 82.5 mL

If the amount collected is outside the range, load a new Pump Set and re-run the test procedure to confirm results.

Section VII — Cleaning

Cleaning should be performed as needed. It may also be desirable to define cleaning intervals based on knowledge of the environment in which the pump is used. Only personnel trained in the cleaning of medical devices should perform cleaning.

Caution: Do not immerse pump or A/C power adapter in water or other cleaning solution; clean using a damp (not wet) cloth or sponge. Failure to follow the cleaning procedures described herein could result in hazards to users. As with any AC powered electrical device, care must be taken to prevent liquid from entering the pump to avoid electrical shock hazard, fire hazard, or damage to electrical components.

If any of the following events occur, **do not use** the pump until it has been properly cleaned and serviced by personnel trained in servicing Kangaroo Epump Enteral Feed and Flush Pumps:

- wetting of the pump's A/C power adapter or leakage into the pump interior during cleaning.
- spillage of large amounts of formula onto the pump exterior, or any spillage onto the A/C power adapter.

General Cleaning Directions

Cleaning of Kangaroo Epump Enteral Feed and Flush Pumps must be performed as follows:

Caution: Disconnect pump from AC power source before cleaning. After cleaning, do not connect to AC power source until pump and A/C power adapter are thoroughly dry.

- A mild detergent should be used for general cleaning. For disinfection a 10% hypochlorite solution, isopropyl alcohol or ammonium chloride based solutions may be used. Allow excess moisture to evaporate from the cord prior to use of A/C Power Adapter.
- **Do not use** strong cleaners such as Spray Nine™, pHisoHex™, Hibiclens™, or Vesta Syde™ or cleaners that may contain Ethoxylated C9-C11 alcohols, 2-Butoxyethanol, Hexachlorophene, Chlorhexidine Gluconate, Subtilisins, Sodium Tetraborate Decahydrate, Triethanolamine, or other similar ingredients because damage to the pump case housing can result.

Directions for Cleaning Pump Housing

- Refer to General Cleaning Directions before starting.
- Clean outside surface with a damp (not wet) cloth or sponge and keep pump in upright position as much as possible.
- Avoid excess moisture near pole clamp area.
- Do not allow cleaning solution to enter the vertical vents in the housing, underneath the handle.

Directions for Cleaning Pump A/C Power Adapter

- Refer to General Cleaning Directions before starting.
- Unless soiling is observed, the A/C power cord should not be cleaned.
- If cleaning of the power adapter is necessary, unplug from outlet and wipe the exterior surfaces of the wall plug with a cloth dampened with isopropyl alcohol.

Caution: Avoid exposing A/C power adapter to excess moisture, as this can lead to an electrical shock or fire hazard.

Directions for Cleaning Rotor Assembly

- Refer to General Cleaning Directions before starting.
- Open the blue door enclosing the Pump Set loading area.
- Loosen rotor set screw with 5/64" (2 mm) allen wrench and gently pull rotor off shaft. After removing rotor, avoid getting any moisture in the rotor shaft opening.
- Clean rollers thoroughly with warm soapy water, or isopropyl alcohol if necessary.
- Be sure all parts of rotor are completely dry before putting it back onto shaft.
- To replace rotor, align set screw on hub of rotor with the flattened section of the output shaft.
- Push rotor into place and tighten set screw (Do not over tighten).

Preventative Maintenance

This pump must be periodically tested to assure proper functioning and safety. The recommended service interval is at least once per year. Performance testing may be done at the user's Biomedical Engineering Department, an outside service, or by Covidien Factory Service. To arrange for Covidien Factory Service in the US, call 1-800-448-0190. In Canada, call 1-877-664-8926. Outside of the US and Canada, please contact your local Customer Service for more information.

If a pump malfunctions, please contact your Covidien Representative or call Customer Service for instruction.

Section VIII — Battery Replacement

See Figure 24 and do the following to replace the Battery Pack:

- Power down the unit.
- Loosen the Battery Door screw, on back of pump.
- Open Battery Door and disconnect wire harness. A small straight-bladed screw driver may be needed to disconnect the connector tab.
- Slide Battery Pack out of compartment.
- Slide a new Battery Pack into compartment with wire harness extending out.
- Align connector with red wire at upper right.
- Push connector in until properly latched.
- **Caution:** Ensure the battery wires are routed through the slot between the connector and the battery to prevent the wires from becoming pinched.
- Re-tighten the Battery Door Screw; if there is any resistance while securing the door, recheck the wires to verify they are properly routed through the wire slot.

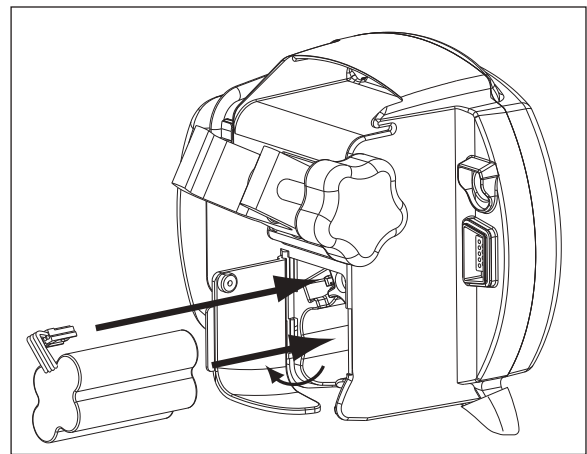

Figure 24. Installation of Battery Pack.

Notes:

- Replacement Battery Packs are available from Covidien (See Section XIII - Service Part Numbers).
- The battery is packed partially charged. Charge battery 6 hours prior to use off A/C power.
- To assure the safe and reliable operation of this pumping system, do not attempt to operate without an approved battery pack installed in the pump.
- Dispose of used battery cells in accordance with local and facility guidelines.
- Keep away from children.

Warning: Use of a battery pack not supplied by Covidien can be dangerous and voids all warranties and performance specifications.

The battery will charge continuously whenever the pump is plugged into a wall outlet. Eight hours of charging is required to fully recharge the Battery Pack.

Section IX — Error/Warning/Informational Screens and Troubleshooting

For operational errors, the Kangaroo Epump Enteral Feed and Flush Pump display will show the error indicator icon, with specific information regarding the error condition, and will sound the alarm.

The following conditions will trigger error conditions and will activate audible and visible alarms:

- Feed or Flush containers are empty
- Feed or Flush tube becomes occluded between bag and pump
- Tube becomes occluded between pump and patient
- Battery low (alarm beeps continuously, about 15 minutes before shut-off)
- Unit is left in HOLD mode longer than 10 minutes without input
- Pump Set tubing is improperly loaded around the rotor
- System errors, see below
- Feeding complete
- The MISTIC connector is removed during **AUTOPRIMING** or **RUNNING**

The Error, Warning, and Information Screens are described below:

System Error (Fixed Audible Volume)

The system error screen is the most general form of error, Figure 25. The only way to exit from a System Error is to power down. No **CONTINUE** option is allowed because of the severity of the error. An error number is also displayed on the screen, for reference purposes. This number should be reported when calling the Customer Service Support Line.

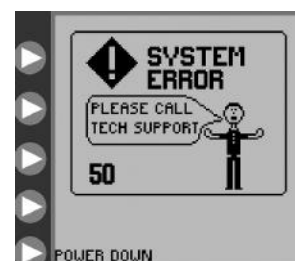



Figure 25. General System Error screen. See Customer Service section.

Error #	Related Sub-system
0	Internal timer stopped.
1	Flash Chip missing OR version incompatible.
2	Too many graphic screens in memory.
4	Never got a ADC ISR for motor current.
5	Never got a ADC ISR for battery level.
6	Never got a ADC ISR for battery temperature.
7	Never got a ADC ISR for Ultrasonic Upstream Occlusion or Bag-Empty checks.
8	Never got a ADC ISR for Ultrasonic during Downstream Occlusion.
9	RS232 Communications Transmission Error.
10	Flash Write Error.
11	Flash Read Error.
12	General Stopcock Time Out.
13	Time Out for Buzzer Test
16	Flash Screen Read Error.
19	Flash Languages Read Error.
20	Could not find Stop Cock Flush Position during prime routine.
21	Could not find Stop Cock Feed Position during prime routine.
22	Motor Error during Tubing AutoLoad.
23	Motor Failsafe Time Out Error. Possible damaged gearbox encoder or flex cable.
25	Display Lockup Time Out Error.
33	Motor Control Failure.

Turn the power off and back on to try to clear the error. If the error cannot be resolved in a timely manner, press  **POWER** to stop operation of the pump and put a different pump into service.

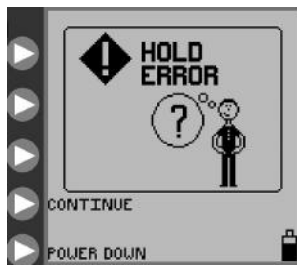

Figure 26. Hold Error screen.

Hold Error (Adjustable Audible Volume)

The **HOLD ERROR** screen will appear if the pump has been inactive, without input, for more than 10 minutes. See subsection “Hold” for description of **HOLDING** mode, Figure 26.

Press ► **CONTINUE** to return to the previous screen. Where settings can be adjusted, the pump can be set to run immediately, or the pump can be set to run in a specified number of minutes. See Figures 18A-18B to see the options on the **HOLDING** menu screen.

If the error cannot be resolved, press ⏻ **POWER** to stop operation of the pump and put a different pump into service.

Rotor Error (Adjustable Audible Volume)

The **ROTOR ERROR** screen appears during **RUNNING** or **PRIMING**, when the pump has detected an unusual operating condition for the rotor. See Figure 27. The **ROTOR ERROR** generally results from a problem with the Pump Set tubing around the rotor.

Check that the Pump Set is not damaged, and re-load the tubing around the rotor as described in subsection “Loading Pump Sets”. Press ► **CONTINUE** to restart.

If the error cannot be resolved, press ⏻ **POWER** to stop operation of the pump and put a different pump into service.

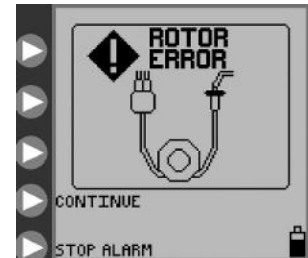

Figure 27. Rotor Error screen. Re-load the set tubing and press CONTINUE.



Figure 28. Feed Error screen.

Feed Error (Adjustable Audible Volume)

The **FEED ERROR** screen appears when the enteral formula is no longer being delivered because the bag is empty or because of a clog between the pump and the bag. Check the feed line to find the occlusion causing the blockage. If the occlusion cannot be cleared, load a new Pump Set, prime it, and restart the feeding, Figure 28.

If the error still cannot be resolved, press ⏻ **POWER** to stop operation of the pump and put a different pump into service.

Flush Error (Adjustable Audible Volume)

The **FLUSH ERROR** screen appears when the flushing solution is no longer being delivered because the flush bag is empty or because of a clog between the pump and flush bag. Check the flush line to find the occlusion causing the blockage. If the occlusion cannot be cleared, load a new Pump Set, prime it, and restart the feeding, Figure 29.

If the error still cannot be resolved, press ⏻ **POWER** to stop operation of the pump and put a different pump into service.



Figure 29. Flush Error screen.

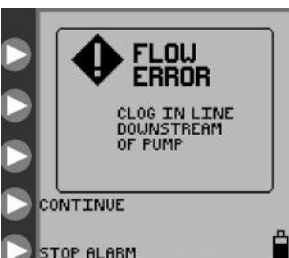

Figure 30. Flow Error screen.

Flow Error (Adjustable Audible Volume)

The **FLOW ERROR** screen appears when the feeding solution is no longer being delivered because of a clog between the pump and the patient. Check the line to find the occlusion causing the blockage. If the error cannot be resolved, check the valve pocket in the Pump Set loading area for dampness or dirt, which may be a cause for a false error. Clean and dry the valve pocket. If the error still cannot be resolved, load a new Pump Set, prime it, and restart the feeding, Figure 30.

If the error still cannot be resolved, press ⏻ **POWER** to stop operation of the pump and put a different pump into service.

Pump Set Dislodged Error (Fixed Audible Volume)

The **PUMP SET DISLODGED** screen will appear if the black ring retainer (MISTIC) is not properly loaded in the MISTIC pocket in the Pump Set loading area. Check and correct the positioning of the MISTIC retainer if possible. If the error cannot be resolved, load a new Pump Set, prime it, and restart the feeding, Figure 31.

If the error cannot be resolved, press **POWER** to stop operation of the pump and put a different pump into service.

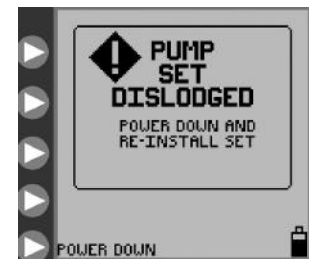

Figure 31. Pump Set Dislodged Error screen.

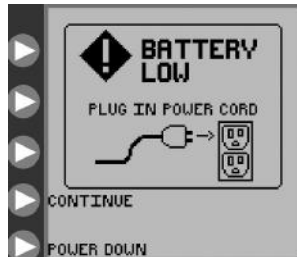

Figure 32. Battery Low error screen. Indicates that the battery must be recharged immediately.

Battery Low (Adjustable Audible Volume)

The **BATTERY LOW** screen appears and the alarm beeps continuously when the battery needs to be recharged. There is approximately 15 minutes of battery life remaining when this screen appears, Figure 32.

Plug the A/C power adapter in to begin recharging. The pump will automatically return to the screen that was active prior to the error. The battery will charge continuously whenever the pump is plugged into a wall outlet. Eight hours of charging is required to fully recharge the battery pack.

Feeding Complete (Adjustable Audible Volume)

The **FEEDING COMPLETE** information screen appears after completion of the programmed feeding, Figure 33. Press **Power Down** to turn off the pump. Press **CONTINUE** to return to the **SET LOADED** opening menu, Figures 7A-7D.



Figure 33. Feeding Complete notification screen.

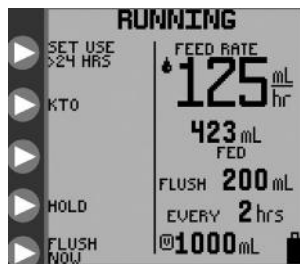

Figure 34. Running screen with the > 24 HRS of Pump Set Usage indicator in upper left of the screen.

Pump Set Use >24 Hours Warning

The Pump Set usage warning indicator will blink on the **RUNNING** screen if a Pump Set has been used for 24 or more hours (hours actually running). It is recommended to replace Pump Sets after this length of usage. This icon is only an informational message and does not require action.

Figure 34 shows an example of the **RUNNING** screen, where a Feed & Flush Set has been in use for more than 24 hours. The informational warning indicator shows up in the upper left on the screen.

LED Array

The pump status LED array on the upper right of the pump gives a quick visual indication of the pump status, especially in darkened rooms.

A green light status indicates normal pump operation.

A yellow light status indicates an informational or warning situation for a low battery condition, the pump in **HOLDING** mode, or one of the following errors: **HOLD ERROR**, **FEED ERROR**, **FLOW ERROR**, and **FLUSH ERROR**.

A red light status indicates a critical pump error. The screen will show one of the following error messages: **SYSTEM ERROR**, **PUMP SET DISLODGED**, or **ROTOR ERROR**.

Section X — Specifications and Symbols

Specifications

TUV Listing

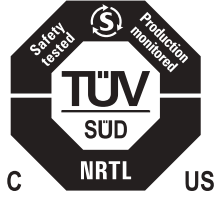

Medical Electrical Equipment

Kangaroo Epump Enteral Feed and Flush Pump with Pole Clamp

(1) Classified with respect to electrical shock, fire, and mechanical hazards in accordance with ES60601-1:2005, UL60601-1.

(2) Classified with respect to electrical shock, fire, mechanical and other specified hazards in accordance with CAN/CSA C22.2 No. 60601-1:08.

Type Infusion Device

Volumetric

Pumping Mechanism

Rotary Peristaltic

Pump Sets

Kangaroo™ Epump MISTIC Feed-Only Set or Feed & Flush Set

Feeding Formula Delivery Rate

1-400 mL/hr in 1 mL increments

Feeding Formula VTBD

1-3000 mL in 1 mL increments

Bolus Volume

1-3000 mL in 1 mL increments

Number of Boluses

1-99

Bolus Interval

1-24 hours in 1-hour increments

Flushing Solution Dose Range

10-500 mL in 1 mL increments

Flushing Solution Interval Range

1-24 hr in 1 hr increments

Accuracy

±10% or 0.5 mL/hr, whichever is larger, with bag at 46 cm (18") above pump, at room temperature $22^{\circ}\text{C} \pm 2^{\circ}\text{C}$ ($72^{\circ}\text{F} \pm 3^{\circ}\text{F}$), using a new pump set with less than the recommended 24 hours of maximum usage.

Occlusion Pressure

15 psi (103 kPa) Nominal

Dimensions

Height: 16.8 cm (6.6") Width: 16.3 cm (6.4") Depth: 11.7 cm (4.6")

Weight

1.1 kg (2.4 lbs), 1.2 kg (2.7 lbs) with pole clamp

Material

Housing: ABS/Polycarbonate blend

Pump Set Door: Polyester/ Polycarbonate blend

Power

Use AC power adapter for wall outlet usage. Pump operates on 9V DC, 1.5 Amps.

Battery

New, fully charged NiMH Battery Pack delivers ≥ 15 hrs at 100 mL/hr feed rate. Approximately 15 minutes prior to complete battery discharge, a low battery alarm will occur (see subsection "Battery Low" in Section IX). When complete discharge occurs, the pump will automatically turn itself off.

The battery will charge continuously whenever the pump is plugged into a wall outlet. Eight hours of charging is required to fully recharge the battery pack.

Alarms

- System Error
- Flow Error
- Pump Set Dislodged Error
- Hold Error
- Rotor Error
- Feed Error
- Flush Error
- Battery Low

Alarm Volume

Minimum of 70 dBA at 1 meter in maximum volume orientation

Operating Temperature

10° - 40° C (50° - 104° F) 75% R.H. non-condensing

Transport & Storage Temperature

0° - 50° C (32° - 122° F) 95% R.H. non-condensing

Type of Protection Against Electrical Shock

Class II, Internally-powered Equipment

Degree of Protection Against Electrical Shock

Type BF

Mode of Operation

Continuous or programmed intermittent operation





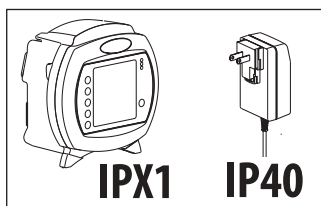















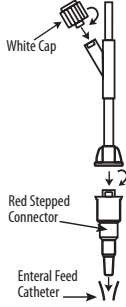

Degree of Protection Against Ingress of Fluids

Drip-proof-IPX1



Symbols on Pump and Accessories

The following symbols are found on the pump or on the accessories, such as the A/C adapter.

	Consult Instructions for Use		Buttons for Selecting Screen Prompts		TUV in USA and Canada
	Type BF Protection (Degree of protection against electrical shock - there is no conductive connection to the patient)		Power Source 9 V DC 1.5 Amp		Set Loading Diagram
	Manufacturing Date Code		DB9 Serial I/O Communication Port (Certification and Programming)		Maximum operating pressure 103 kPa
SN	Serial Number		Caution: For indoor use only		Assure that the white cap and red stepped connector are securely tightened
REF	Reorder number for the device located on the carton label		Functional Ground		
	Alternating Current		Do not use Kangaroo Epump Feeding Sets for greater than 24 hours		
	Class II Equipment (degree of protection against electrical shock), Double Insulated		Do not use if unit package is open or damaged		
	Direct Current (DC)		Flushing Solution		
IPX1	Drip Proof (Degree of protection against ingress of fluids)		Feeding Formula		
	CE Mark – European Community Certification		See Kangaroo Epump Manual for Feeding Set loading instructions		
	Power Button		European Union's Waste Electrical and Electric Equipment (WEEE) Directive in accordance with European Standard EN 50419		

Section XI — Customer Service

The circuitry of the Kangaroo Epump Enteral Feed and Flush Pump is not customer serviceable. In particular, electronic assembly rework by non-authorized Kangaroo Epump Enteral Feed and Flush Pump technicians will likely affect accuracy.

All service personnel must be properly trained and qualified with operation of the Kangaroo Epump Enteral Feed and Flush Pump. Improper service may impair operation of the pump.

Return for Repair

1. Call Customer Service for an Authorized Return Number and shipping instructions, using the appropriate phone number below:
2. Pack the instrument carefully and ship the insured parcel to:

United States

Covidien
5920 Longbow Drive
Boulder, CO 80301, USA
Phone: 1-800-448-0190

Canada

Covidien
7300 Trans Canada Highway
Pointe-Claire, QC H9R 1C7, Canada
Phone: 1-877-664-8926

Outside US & Canada

Covidien
Unit 2 Talisman Business Center, London Road
Bicester, OX266HR, UK
Phone: +44-1869-328065

Section XII — Maintenance

For general maintenance issues not discussed below, contact Customer Service (Section XI).

Warning: Do not open the main housing, as there are no user-serviceable parts inside. Opening of device may affect function of device and voids the warranty.

The following maintenance items/parts can be replaced by the customer on the Kangaroo Epump Enteral Feed and Flush Pump. See Section XIII for Service Part Numbers and Section XI for contacting Customer Service.

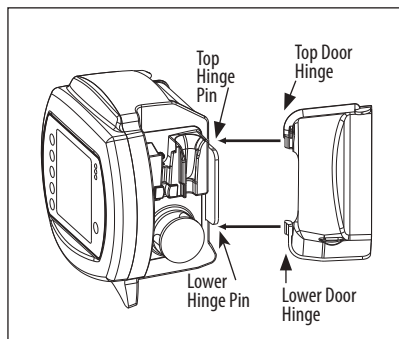

Figure 35. Blue Door Replacement.

Side Door enclosing Pump Set Loading area

To replace the Side Door, see Figure 35 and do the following:

1. Place top Door Hinge onto the Top Hinge Pin.
2. Carefully press down on the bottom of the door to spread the door hinges apart.
3. Place the bottom Door Hinge onto the Bottom Hinge Pin.

Battery Pack

See Section VIII for full instructions on replacing Battery Pack. During long-term non-usage or storage (greater than 9 months) of the pump, battery discharge and deactivation may tend to occur. It is recommended that the battery be disconnected during this time. The battery may need to be charged and discharged several times to restore optimal capacity.

Battery Door

To replace Battery Door, see Figure 36 and do the following:

1. Align the Battery Door Hinges with the long hinge pins.
2. Snap the hinges onto the hinge pins.
3. Screw down the door to hold in place.

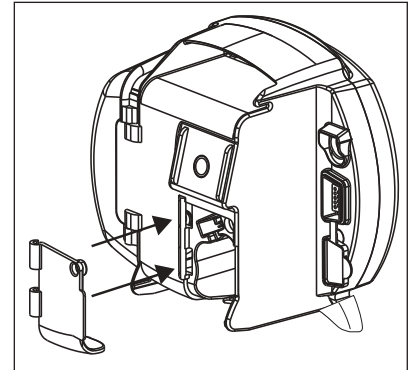

Figure 36. Battery Door Replacement.

A/C Power Adapter

See Section IV for initial setup, including A/C Power Adapter attachment.

Pole Clamp

See Section IV for initial setup, including attachment of the Pole Clamp to the pump.

Section XIII – Service Part Numbers

To place an order for parts, or if technical assistance is required, call customer service.

The Kangaroo Epump Enteral Feed and Flush Pump contains a limited number of serviceable parts, Figure 37. User maintenance is to be performed only by appropriately qualified technical personnel.

Visit our web site at: www.covidien.com

- | | |
|--------------------------------|-------------|
| 1 Kangaroo Epump: | |
| <i>US:</i> | • 382400 |
| <i>International:</i> | • 482400 |
| 2 Main Door: | • F31877WT |
| <i>(Blue transparent door)</i> | |
| 3 Battery Pack: | • 1041411 |
| 4 Battery Door: | • F31878WT |
| <i>(with screw)</i> | |
| A/C Power Adapter: | • 382491(5) |
| 5 Pole Clamp: | • 382492 |
| Electrical Plugs | • 382493 |
| <i>(Set of 4)</i> | |

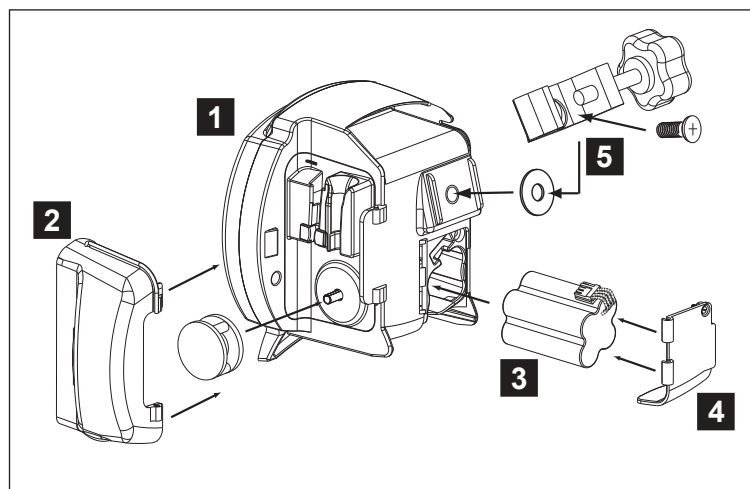

Figure 37. User Serviceable Parts.

Section XIV – Warranty

Limited Warranty:

1. Covidien warrants to the original purchaser (“Customer”) that this newly manufactured enteral feeding pump (“Pump” or “Pumps”) will be free of defects in materials and workmanship, under normal use, for three (3) years from the date of shipment from Covidien. This Limited Warranty as applied to Pump batteries and power cords is limited to one (1) year from the date of shipment from Covidien for all Pumps.
2. This Limited Warranty does not extend to routine maintenance of Pumps such as cleaning and all recommended Performance Tests set forth in this Pump Operation and Service Manual which remain the sole responsibility of Customer. Failure of Customer to perform cleaning, routine maintenance and recommended performance testing on any Pump as outlined in this Pump Operation and Service Manual may void this Limited Warranty.
3. Customer agrees that, with the exception of customer serviceable parts and troubleshooting steps outlined in this Pump Operation and Service Manual, Covidien or its authorized dealer must perform Pump repairs.
4. This Limited Warranty does not cover any Pump, product or part that:
 - (a) has been operated in an unsuitable environment or used for purposes other than intended;
 - (b) has been subjected to unauthorized or non-Covidien repair or use of non-Covidien supplied parts;
 - (c) has been altered, misused, abused or neglected;
 - (d) has been subjected to fire, casualty or accident;
 - (e) suffers damage caused by Customer’s negligent acts or omissions; or
 - (f) suffers damage beyond normal wear and tear.
5. For purposes of this Limited Warranty, “damage beyond normal wear and tear” includes without limitation:
 - (a) Damage to housing, LCD, display overlay or power supply;
 - (b) PCBA damage due to fluid ingress;
 - (c) Use of non-qualified power supply or battery; or
 - (d) Use of unauthorized cleaning fluids.
6. If a Pump does not operate as warranted during the applicable warranty period, Covidien may, at its option and expense,
 - (a) repair or replace the defective part or Pump; or,
 - (b) refund to Customer the purchase price for the defective part or Pump.
7. Dated proof of original purchase is required to process warranty claims. Removal, defacement or alteration of serial lot number voids this Limited Warranty.
8. Shipping costs for Pumps being returned to Covidien shall be borne by Customer. Customer is responsible for proper packaging for return shipment. Loss or damage in return shipment to Covidien shall be at Customer’s risk.
9. Covidien disclaims all other warranties, expressed or implied, including any implied warranty of merchantability or fitness for a particular purpose or application other than as expressly set forth in the product labeling. In no event shall Covidien be liable for any incidental, indirect or consequential damages in conjunction with the purchase or use of the Pump, even if advised of the possibility of the same.

Section XV – Electromagnetic Conformity Declaration

The Kangaroo Epump Enteral Feed and Flush Pump has been built and tested according to UL60601-1-1, ES60601-1:2005, CAN/CSA-C22.2 No.60601-1:08, EN60601-1:2006 and EN60601-1-2 Standards.

The Kangaroo Epump Enteral Feed and Flush Pump is intended for use in the electromagnetic environment specified below. The user of the pump should assure that it is used in such an environment.

Emissions Test	Compliance	Electromagnetic Environment - Guidance
RF emissions (CISPR 11)	Group 1	The Kangaroo Epump Enteral Feed and Flush Pump uses RF energy only for its internal function. Therefore, its RF emissions are very low and are not likely to cause any interference in nearby electronic equipment.
RF emissions (CISPR 11)	Class B	The Kangaroo Epump Enteral Feed and Flush Pump is suitable for use in all establishments, including domestic establishments and those directly connected to the public low-voltage power supply network that supplies buildings used for domestic purposes.
Harmonic emissions (IEC 61000-3-2)	Class A	
Voltage fluctuations/ flicker emissions (IEC 61000-3-3)	Complies	
Radiated Disturbance Immunity (EN60601-1-2 / IEC 61000-4-3:2002)	Complies	
Conducted Disturbance Immunity (EN60601-1-2 / IEC 61000-4-6:2001)	Complies	
Power Frequency Magnetic Field Immunity (EN60601-1-2 / IEC 61000-4-8:2001)	Complies	
Voltage dips and sags Immunity (EN60601-1-2 / IEC 61000-4-11:2001)	Complies	
Electrical Fast Transient / Bursts Immunity (EN60601-1-2 / IEC 61000-4-4:2001)	Complies	
Electrostatic Discharge Immunity (EN60601-1-2 / IEC 61000-4-2:2001)	Complies	
Surge Immunity (EN60601-1-2 / IEC 61000-4-5:2001)	Complies	



Manual No. SMF0211-079

U.S. Patents 7,092,797; 7,447,566; 7,608,059; 7,843,328.

COVIDIEN, COVIDIEN with logo and Covidien logo are U.S. and internationally registered trademarks of Covidien AG.

TM*Spray Nine is a trademark of Spray Nine Corp.

TM*pHisoHex is a trademark of The Mentholatum Co.

TM*Hibiclens is a trademark of Regent Medical Ltd.

TM*Vesta Syde is a trademark of Steris Inc.

Other brands are trademarks of a Covidien company.

© 2012 Covidien.

 Covidien llc, 15 Hampshire Street, Mansfield, MA 02048 USA.

 Covidien Ireland Limited, IDA Business & Technology Park, Tullamore.
www.covidien.com 1-800-962-9888 [T]

REV 03/2012